

PROJECT	_____
TYPE	_____
SPECIFIER	_____
QUANTITY	_____
DATE	_____

## NONAME SUSPENSION

### D41096-

base number	LED	Color	Finish
	Dimming	Temperature	Options

- To build a product code in our configurator select the specify button on the base model # product page
- To build a manual product code on this datasheet choose from the options listed below in blue font and add the suffix to the base model #

#### GENERAL

Series: NoName
Partner: Icone
Division: Design
Installation: Suspension
Product Type: Pendant
Mounting Location: Ceiling
Light Distribution: Direct

#### PHYSICAL

Shape: Abstract
Length (mm): 1315
Length (in): 51 3/4
Width (mm): 300
Width (in): 11 13/16
Height (mm): 30
Height (in): 1 3/16
Max. Overall Height (mm): 2500
Max. Overall Height (in): 98 7/16
Fixture Finish: <a href="#">BLK</a> / <a href="#">WHB</a> / <a href="#">WHW</a> / <a href="#">BKB</a> / <a href="#">BRA</a> / <a href="#">SBS</a>
Fixture Material: Aluminum
Cable Details: 1500mm / 59 1/16"

#### ELECTRICAL

Lamp Type: LED
Input Wattage (W): 41.6
<a href="#">Dimming: Phase Dimming / 0-10V Dimming</a>
Driver Included: Yes
Driver Location: Integrated
Driver Class: Class 2
Input Voltage (V): 120 - 277
Output Voltage (V): 24

#### LED

<a href="#">Color Temperature (°K): 2700 / 3000</a>
Max. Delivered Lumen (lm): 5700 / 5880
CRI: >80 CRI
Lamp Life (hrs): 50000

#### OPTICAL

#### RATINGS AND CERTIFICATIONS

Certified By: Certified for North American Standards
IP rating: IP20

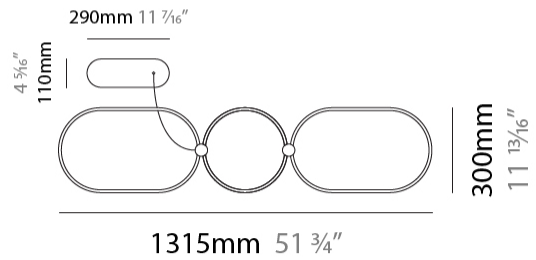

D41096-

PROJECT
TYPE
SPECIFIER
QUANTITY
DATE

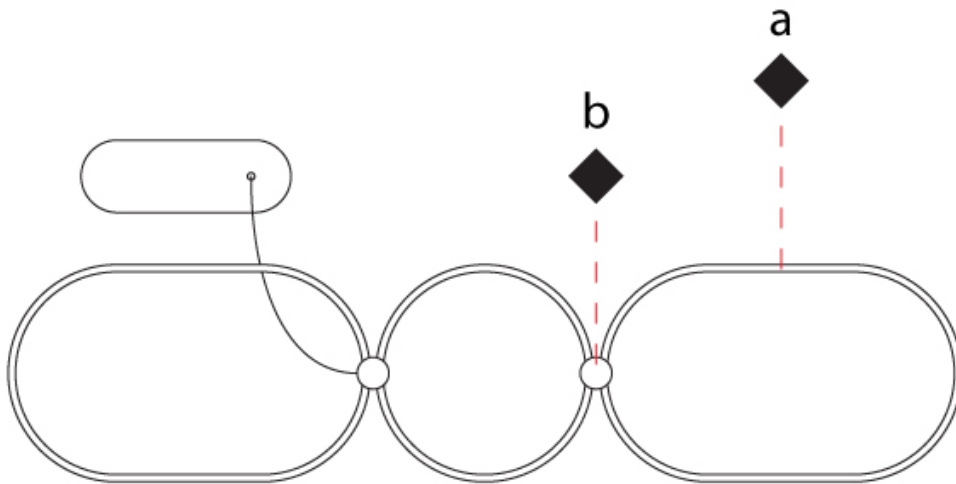

D

## NONAME SUSPENSION

### D41097-

base number    LED Dimming    Color Temperature    Finish Options

PROJECT
TYPE
SPECIFIER
QUANTITY
DATE

- To build a product code in our configurator select the specify button on the base model # product page
- To build a manual product code on this datasheet choose from the options listed below in blue font and add the suffix to the base model #

#### GENERAL

Series: NoName  
 Partner: Icone  
 Division: Design  
 Installation: Suspension  
 Product Type: Pendant  
 Mounting Location: Ceiling  
 Light Distribution: Indirect

#### PHYSICAL

Shape: Abstract  
 Length (mm): 1315  
 Length (in): 51 3/4  
 Width (mm): 300  
 Width (in): 11 13/16  
 Max. Overall Height (mm): 2500  
 Max. Overall Height (in): 98 7/16  
 Fixture Finish: [BLK](#) / [WHB](#) / [WHW](#) / [BKB](#) / [BRA](#) / [SBS](#)  
 Fixture Material: Aluminum  
 Cable Details: 1500mm / 59 1/16"

#### ELECTRICAL

Lamp Type: LED  
 Input Wattage (W): 41.6  
 Dimming: [Phase Dimming](#) / [0-10V Dimming](#)  
 Driver Included: Yes  
 Driver Location: Integrated  
 Driver Class: Class 2  
 Input Voltage (V): 120 - 277  
 Output Voltage (V): 24

#### LED

Color Temperature (°K): [2700](#) / [3000](#)  
 Max. Delivered Lumen (lm): 5700 / 5880  
 CRI: >80 CRI  
 Lamp Life (hrs): 50000

#### OPTICAL

#### RATINGS AND CERTIFICATIONS

Certified By: Certified for North American Standards  
 IP rating: IP20

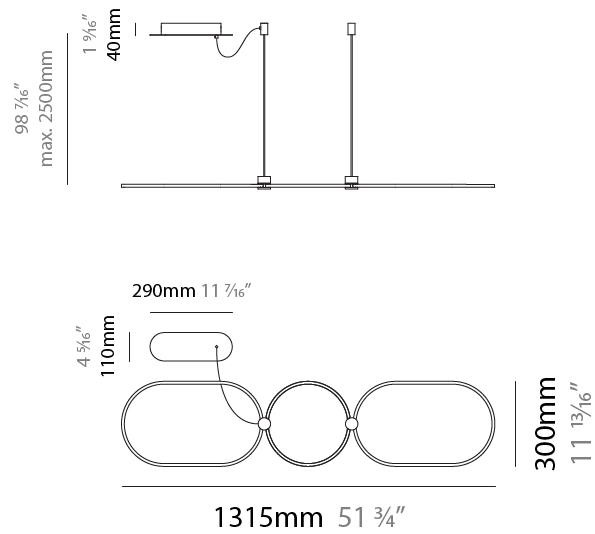

D41097-

PROJECT

TYPE

SPECIFIER

QUANTITY

DATE

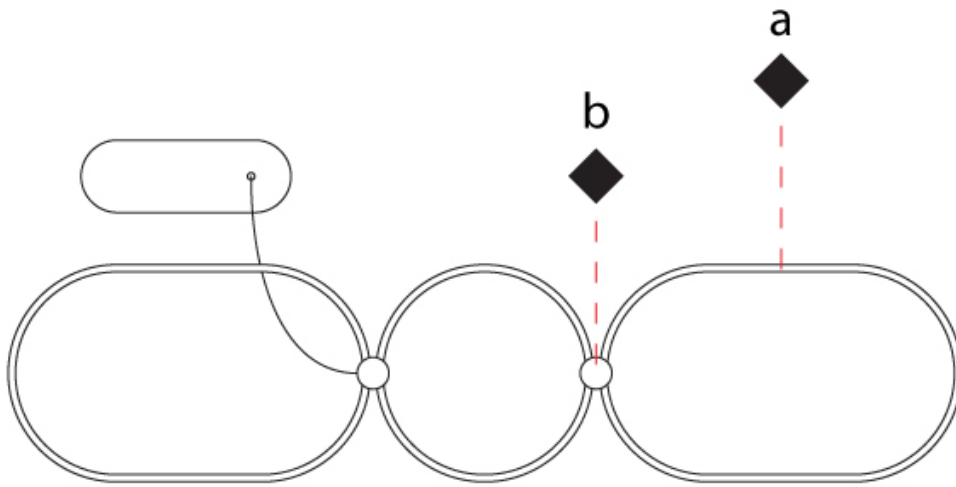

D

PROJECT	_____
TYPE	_____
SPECIFIER	_____
QUANTITY	_____
DATE	_____

## NONAME SUSPENSION

### D41098-

base number	LED	Color	Finish
	Dimming	Temperature	Options

- To build a product code in our configurator select the specify button on the base model # product page
- To build a manual product code on this datasheet choose from the options listed below in blue font and add the suffix to the base model #

#### GENERAL

Series: NoName
Partner: Icone
Division: Design
Installation: Suspension
Product Type: Pendant
Mounting Location: Ceiling
Light Distribution: Direct / Indirect

#### PHYSICAL

Shape: Abstract
Length (mm): 1315
Length (in): 51 3/4
Width (mm): 300
Width (in): 11 13/16
Max. Overall Height (mm): 2500
Max. Overall Height (in): 98 7/16
Fixture Finish: <a href="#">BLK</a> / <a href="#">WHB</a> / <a href="#">WHW</a> / <a href="#">BKB</a> / <a href="#">BRA</a> / <a href="#">SBS</a>
Fixture Material: Aluminum
Cable Details: 1500mm / 59 1/16"

#### ELECTRICAL

Lamp Type: LED
Input Wattage (W): 41.6
Dimming: <a href="#">Phase Dimming / 0-10V Dimming</a>
Driver Included: Yes
Driver Location: Integrated
Driver Class: Class 2
Input Voltage (V): 120 - 277
Output Voltage (V): 24

#### LED

Color Temperature (°K): <a href="#">2700</a> / <a href="#">3000</a>
Max. Delivered Lumen (lm): 5700 / 5880
CRI: >80 CRI
Lamp Life (hrs): 50000

#### OPTICAL

#### RATINGS AND CERTIFICATIONS

Certified By: Certified for North American Standards
IP rating: IP20

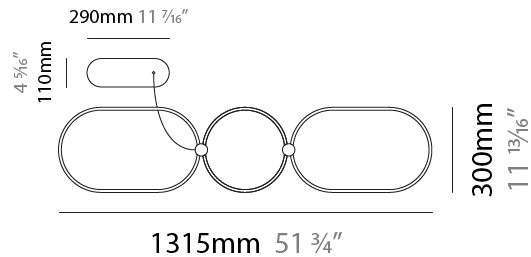
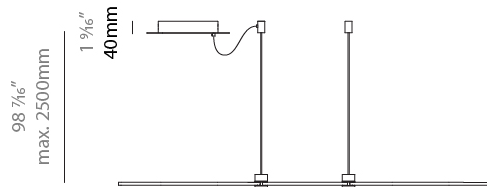

D41098-

PROJECT

TYPE

SPECIFIER

QUANTITY

DATE

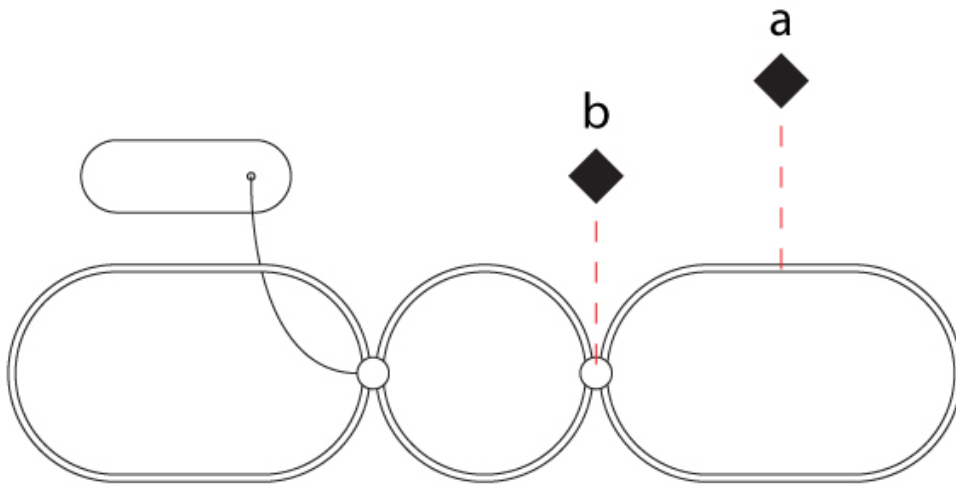

D

## NONAME SUSPENSION

### D41099-

base number    LED Dimming    Color Temperature    Finish Options

- To build a product code in our configurator select the specify button on the base model # product page
- To build a manual product code on this datasheet choose from the options listed below in blue font and add the suffix to the base model #

#### GENERAL

Series: NoName  
 Partner: Icone  
 Division: Design  
 Installation: Suspension  
 Product Type: Pendant  
 Mounting Location: Ceiling  
 Light Distribution: Direct

#### PHYSICAL

Shape: Abstract  
 Length (mm): 910  
 Length (in): 35 <sup>13</sup>/<sub>16</sub>"  
 Width (mm): 305  
 Width (in): 12  
 Height (mm): 30  
 Height (in): 1 <sup>3</sup>/<sub>16</sub>"  
 Max. Overall Height (mm): 2500  
 Max. Overall Height (in): 98 <sup>7</sup>/<sub>16</sub>"  
 Fixture Finish: [BLK](#) / [WHB](#) / [WHW](#) / [BKB](#) / [BRA](#) / [SBS](#)  
 Fixture Material: Aluminum

#### ELECTRICAL

Lamp Type: LED  
 Input Wattage (W): 51  
 Dimming: [Phase Dimming](#) / [0-10V Dimming](#)  
 Driver Included: Yes  
 Driver Location: Integrated  
 Driver Class: Class 2  
 Input Voltage (V): 120 - 277  
 Output Voltage (V): 24

#### LED

Color Temperature (°K): [2700](#) / [3000](#)  
 Max. Delivered Lumen (lm): 7050 / 7270  
 CRI: >80 CRI  
 Lamp Life (hrs): 50000

#### OPTICAL

#### RATINGS AND CERTIFICATIONS

Certified By: Certified for North American Standards  
 IP rating: IP20

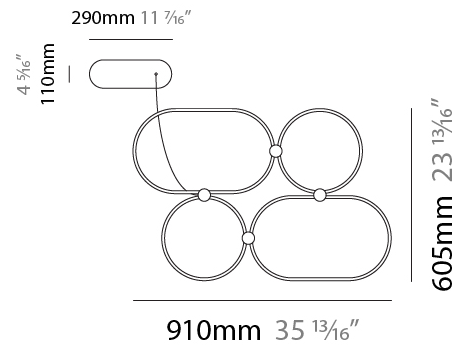
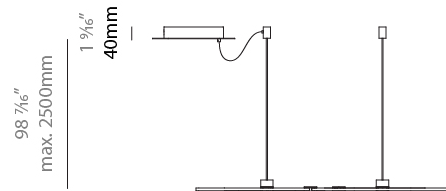

D41099-

PROJECT	_____
TYPE	_____
SPECIFIER	_____
QUANTITY	_____
DATE	_____

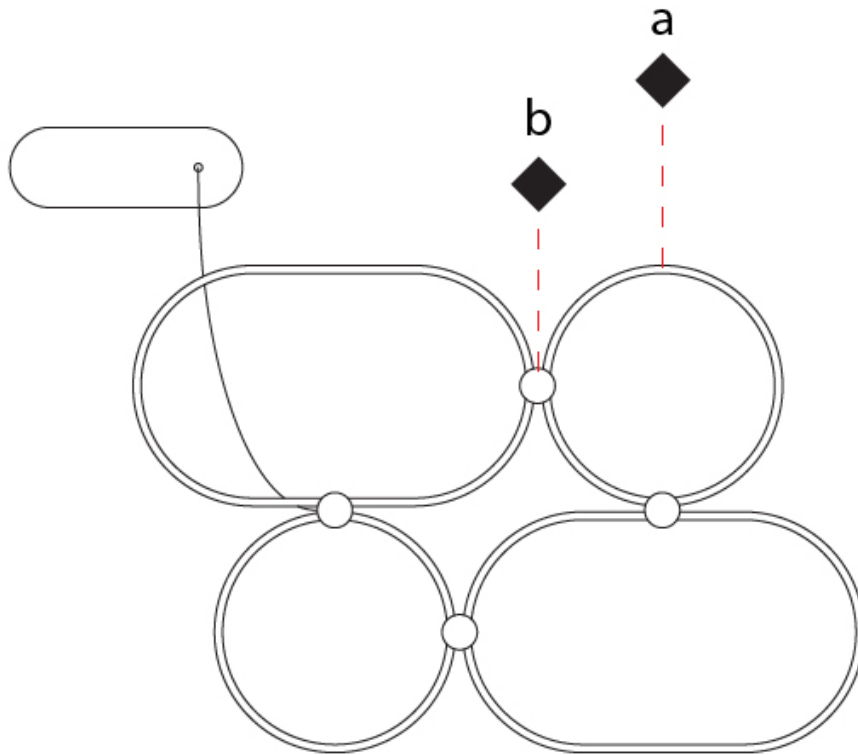

D

PROJECT	_____
TYPE	_____
SPECIFIER	_____
QUANTITY	_____
DATE	_____

## NONAME SUSPENSION

### D41100-

base number	LED	Color	Finish
	Dimming	Temperature	Options

- To build a product code in our configurator select the specify button on the base model # product page
- To build a manual product code on this datasheet choose from the options listed below in blue font and add the suffix to the base model #

#### GENERAL

Series: NoName
Partner: Icone
Division: Design
Installation: Suspension
Product Type: Pendant
Mounting Location: Ceiling
Light Distribution: Indirect

#### PHYSICAL

Shape: Abstract
Length (mm): 910
Length (in): 35 <sup>13</sup> / <sub>16</sub>
Width (mm): 305
Width (in): 12
Height (mm): 30
Height (in): 1 <sup>3</sup> / <sub>16</sub>
Max. Overall Height (mm): 2500
Max. Overall Height (in): 98 <sup>7</sup> / <sub>16</sub>
Fixture Finish: <a href="#">BLK</a> / <a href="#">WHB</a> / <a href="#">WHW</a> / <a href="#">BKB</a> / <a href="#">BRA</a> / <a href="#">SBS</a>
Fixture Material: Aluminum

#### ELECTRICAL

Lamp Type: LED
Input Wattage (W): 51
Dimming: <a href="#">Phase Dimming</a> / <a href="#">0-10V Dimming</a>
Driver Included: Yes
Driver Location: Integrated
Driver Class: Class 2
Input Voltage (V): 120 - 277
Output Voltage (V): 24

#### LED

Color Temperature (°K): <a href="#">2700</a> / <a href="#">3000</a>
Max. Delivered Lumen (lm): 7050 / 7270
CRI: >80 CRI
Lamp Life (hrs): 50000

#### OPTICAL

#### RATINGS AND CERTIFICATIONS

Certified By: Certified for North American Standards
IP rating: IP20

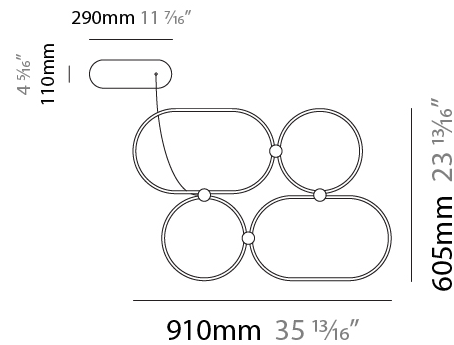
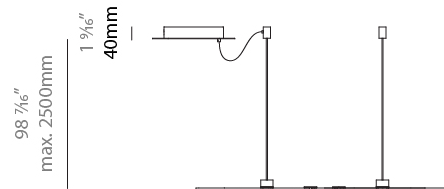

D41100-

PROJECT \_\_\_\_\_

TYPE \_\_\_\_\_

SPECIFIER \_\_\_\_\_

QUANTITY \_\_\_\_\_

DATE \_\_\_\_\_

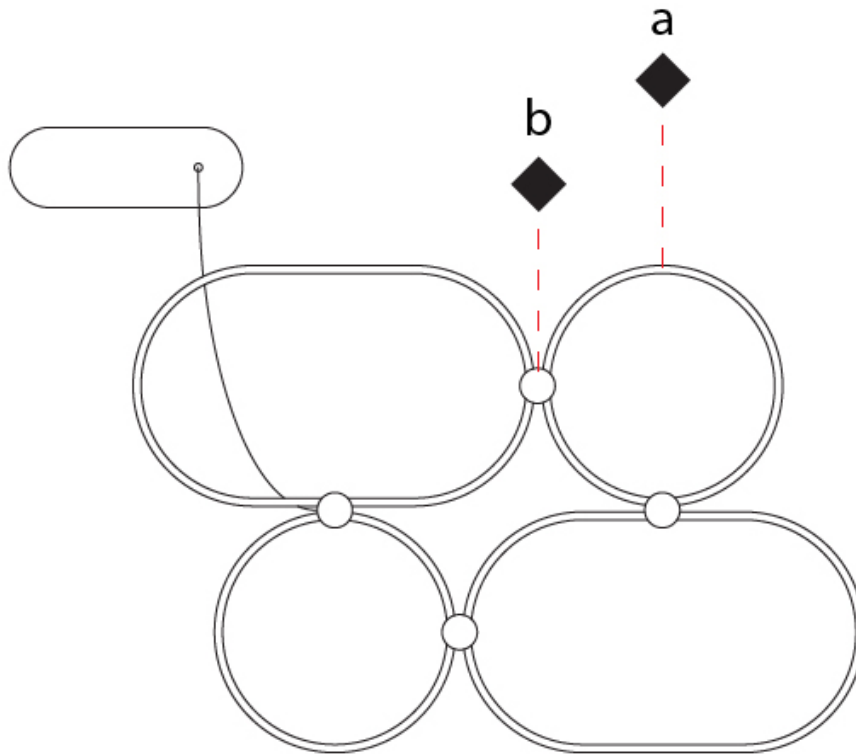

D

PROJECT	_____
TYPE	_____
SPECIFIER	_____
QUANTITY	_____
DATE	_____

## NONAME SUSPENSION

### D41101-

base number	LED	Color	Finish
	Dimming	Temperature	Options

- To build a product code in our configurator select the specify button on the base model # product page
- To build a manual product code on this datasheet choose from the options listed below in blue font and add the suffix to the base model #

#### GENERAL

Series: NoName
Partner: Icone
Division: Design
Installation: Suspension
Product Type: Pendant
Mounting Location: Ceiling
Light Distribution: Direct / Indirect

#### PHYSICAL

Shape: Abstract
Length (mm): 910
Length (in): 35 <sup>13</sup> / <sub>16</sub> "
Width (mm): 305
Width (in): 12
Height (mm): 30
Height (in): 1 <sup>3</sup> / <sub>16</sub> "
Max. Overall Height (mm): 2500
Max. Overall Height (in): 98 <sup>7</sup> / <sub>16</sub> "
Fixture Finish: <a href="#">BLK</a> / <a href="#">WHB</a> / <a href="#">WHW</a> / <a href="#">BKB</a> / <a href="#">BRA</a> / <a href="#">SBS</a>
Fixture Material: Aluminum

#### ELECTRICAL

Lamp Type: LED
Input Wattage (W): 51
<a href="#">Dimming: Phase Dimming / 0-10V Dimming</a>
Driver Included: Yes
Driver Location: Integrated
Driver Class: Class 2
Input Voltage (V): 120 - 277
Output Voltage (V): 24

#### LED

<a href="#">Color Temperature (°K): 2700 / 3000</a>
Max. Delivered Lumen (lm): 7050 / 7270
CRI: >80 CRI
Lamp Life (hrs): 50000

#### OPTICAL

#### RATINGS AND CERTIFICATIONS

Certified By: Certified for North American Standards
IP rating: IP20

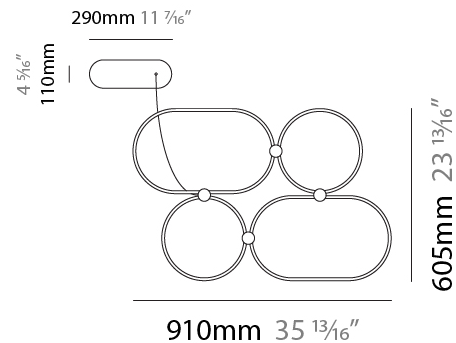
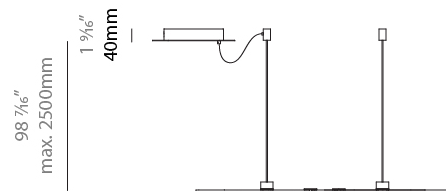

D41101-

PROJECT \_\_\_\_\_

TYPE \_\_\_\_\_

SPECIFIER \_\_\_\_\_

QUANTITY \_\_\_\_\_

DATE \_\_\_\_\_

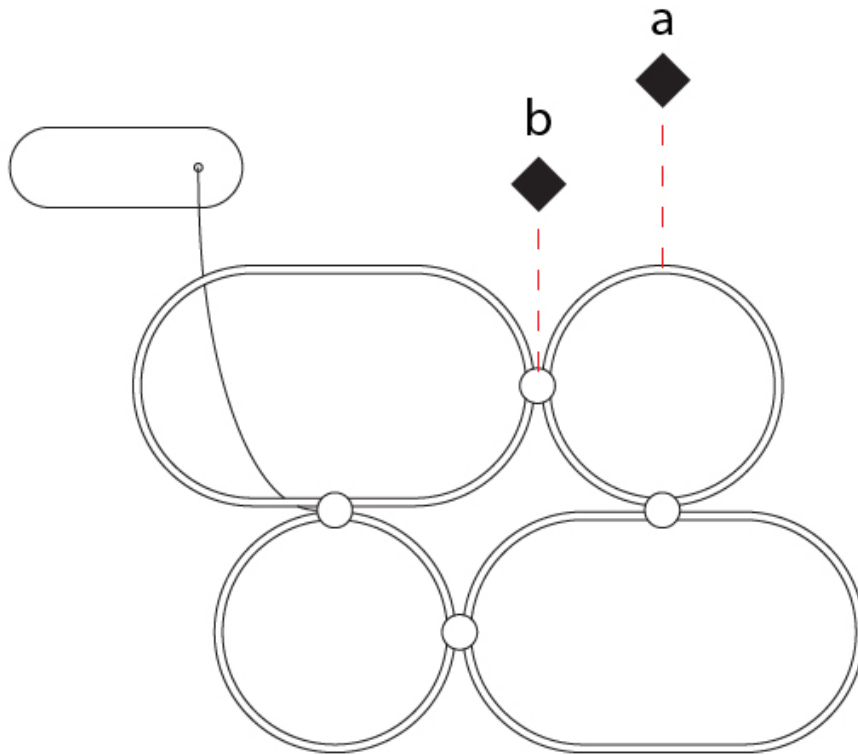

D

## NONAME SUSPENSION

### D41102-

base number    LED Dimming    Color Temperature    Finish Options

- To build a product code in our configurator select the specify button on the base model # product page
- To build a manual product code on this datasheet choose from the options listed below in blue font and add the suffix to the base model #

#### GENERAL

Series: NoName  
 Partner: Icone  
 Division: Design  
 Installation: Suspension  
 Product Type: Pendant  
 Mounting Location: Ceiling  
 Light Distribution: Direct

#### PHYSICAL

Shape: Abstract  
 Length (mm): 1315  
 Length (in): 51 3/4  
 Width (mm): 920  
 Width (in): 36 1/4  
 Height (mm): 30  
 Height (in): 1 3/16  
 Max. Overall Height (mm): 2500  
 Max. Overall Height (in): 98 7/16  
 Fixture Finish: [BLK / WHB / WHW / BKB / BRA / SBS](#)  
 Fixture Material: Aluminum

#### ELECTRICAL

Lamp Type: LED  
 Input Wattage (W): 116  
 Dimming: [Phase Dimming / 0-10V Dimming](#)  
 Driver Included: Yes  
 Driver Location: Integrated  
 Driver Class: Class 2  
 Input Voltage (V): 120 - 277  
 Output Voltage (V): 24

#### LED

[Color Temperature \(°K\): 2700 / 3000](#)  
 Max. Delivered Lumen (lm): 15900 / 16500  
 CRI: >80 CRI  
 Lamp Life (hrs): 50000

#### OPTICAL

#### RATINGS AND CERTIFICATIONS

Certified By: Certified for North American Standards  
 IP rating: IP20

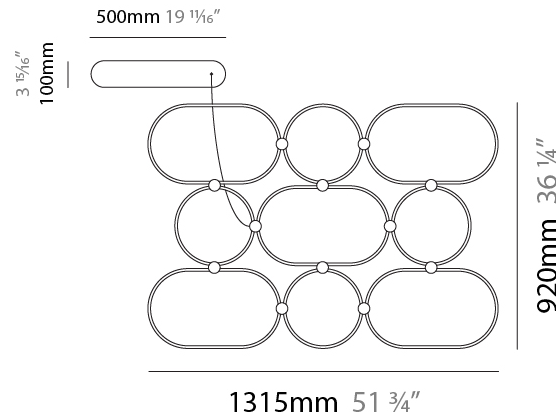

D41102-

PROJECT	_____
TYPE	_____
SPECIFIER	_____
QUANTITY	_____
DATE	_____

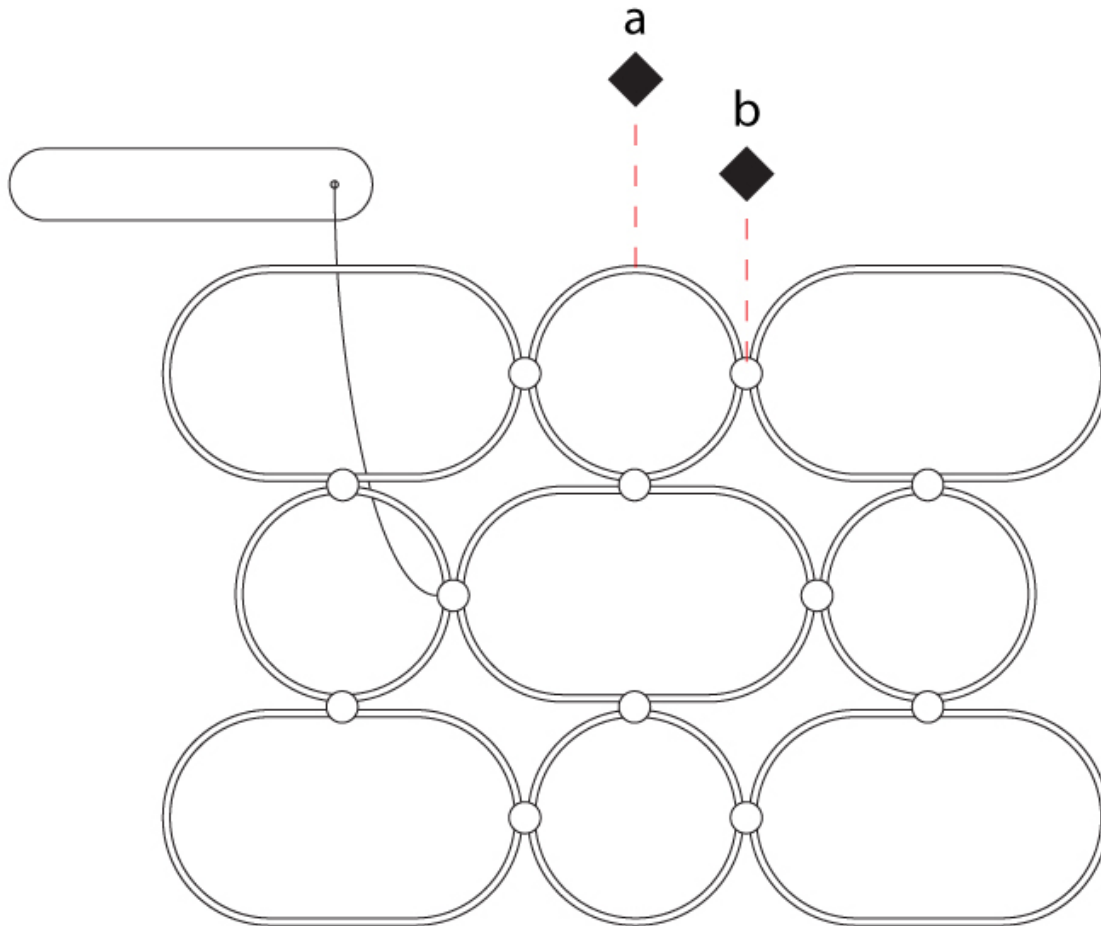

D

## NONAME SUSPENSION

### D41103-

base number LED Dimming Color Temperature Finish Options

- To build a product code in our configurator select the specify button on the base model # product page
- To build a manual product code on this datasheet choose from the options listed below in blue font and add the suffix to the base model #

#### GENERAL

Series: NoName  
 Partner: Icone  
 Division: Design  
 Installation: Suspension  
 Product Type: Pendant  
 Mounting Location: Ceiling  
 Light Distribution: Indirect

#### PHYSICAL

Shape: Abstract  
 Length (mm): 1315  
 Length (in): 51 3/4  
 Width (mm): 920  
 Width (in): 36 1/4  
 Height (mm): 30  
 Height (in): 1 3/16  
 Max. Overall Height (mm): 2500  
 Max. Overall Height (in): 98 7/16  
 Fixture Finish: [BLK / WHB / WHW / BKB / BRA / SBS](#)  
 Fixture Material: Aluminum

#### ELECTRICAL

Lamp Type: LED  
 Input Wattage (W): 116  
 Dimming: [Phase Dimming / 0-10V Dimming](#)  
 Driver Included: Yes  
 Driver Location: Integrated  
 Driver Class: Class 2  
 Input Voltage (V): 120 - 277  
 Output Voltage (V): 24

#### LED

[Color Temperature \(°K\): 2700 / 3000](#)  
 Max. Delivered Lumen (lm): 15900 / 16500  
 CRI: >80 CRI  
 Lamp Life (hrs): 50000

#### OPTICAL

#### RATINGS AND CERTIFICATIONS

Certified By: Certified for North American Standards  
 IP rating: IP20

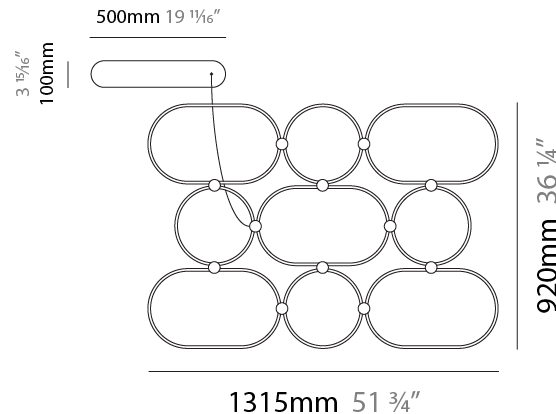
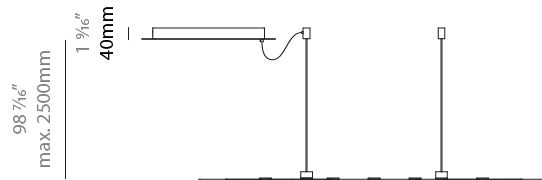

D41103-

PROJECT

TYPE

SPECIFIER

QUANTITY

DATE

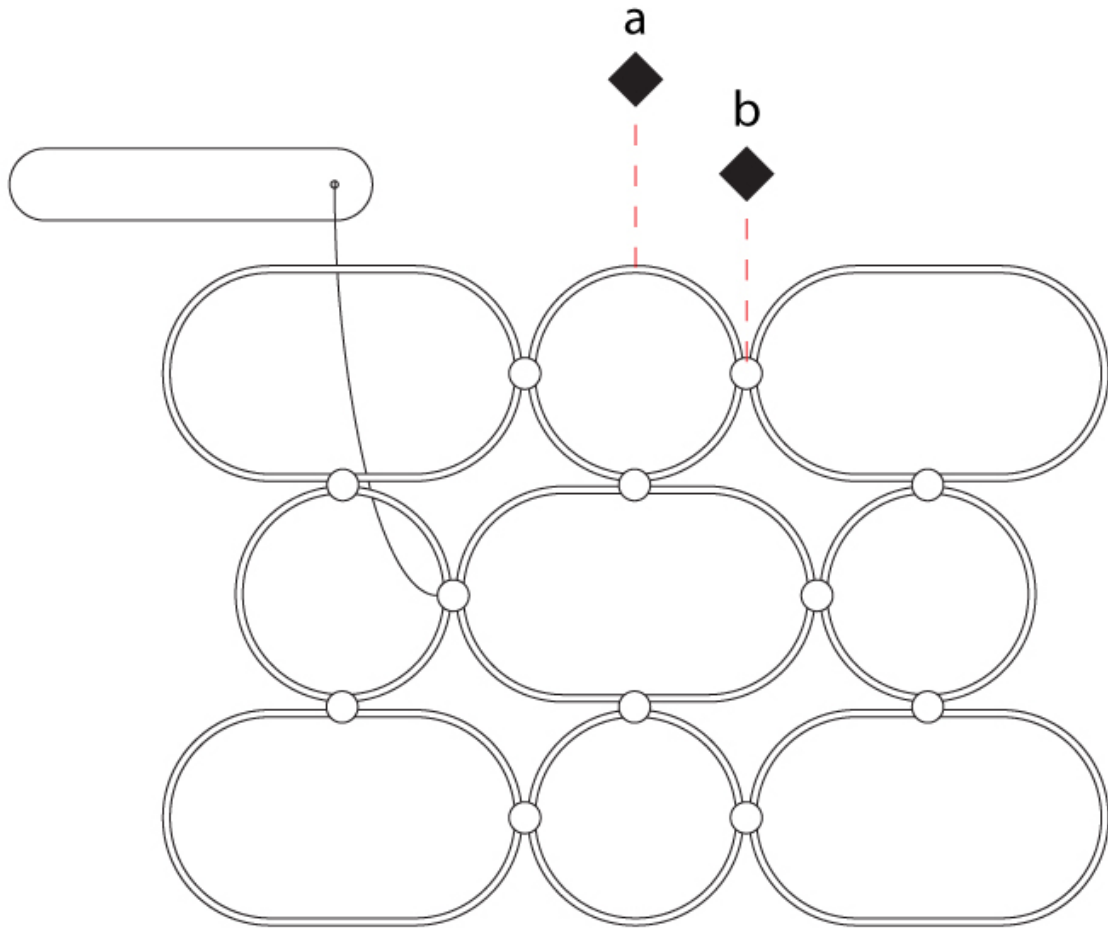

D

## NONAME SUSPENSION

### D41104-

base number    LED    Color    Finish  
 Dimming    Temperature    Options

- To build a product code in our configurator select the specify button on the base model # product page
- To build a manual product code on this datasheet choose from the options listed below in blue font and add the suffix to the base model #

#### GENERAL

Series: NoName  
 Partner: Icone  
 Division: Design  
 Installation: Suspension  
 Product Type: Pendant  
 Mounting Location: Ceiling  
 Light Distribution: Direct / Indirect

#### PHYSICAL

Shape: Abstract  
 Length (mm): 1315  
 Length (in): 51 3/4  
 Width (mm): 920  
 Width (in): 36 1/4  
 Height (mm): 30  
 Height (in): 1 3/16  
 Max. Overall Height (mm): 2500  
 Max. Overall Height (in): 98 7/16  
 Fixture Finish: [BLK / WHB / WHW / BKB / BRA / SBS](#)  
 Fixture Material: Aluminum

#### ELECTRICAL

Lamp Type: LED  
 Input Wattage (W): 116  
 Dimming: [Phase Dimming / 0-10V Dimming](#)  
 Driver Included: Yes  
 Driver Location: Integrated  
 Driver Class: Class 2  
 Input Voltage (V): 120 - 277  
 Output Voltage (V): 24

#### LED

[Color Temperature \(°K\): 2700 / 3000](#)  
 Max. Delivered Lumen (lm): 15900 / 16500  
 CRI: >80 CRI  
 Lamp Life (hrs): 50000

#### OPTICAL

#### RATINGS AND CERTIFICATIONS

Certified By: Certified for North American Standards  
 IP rating: IP20

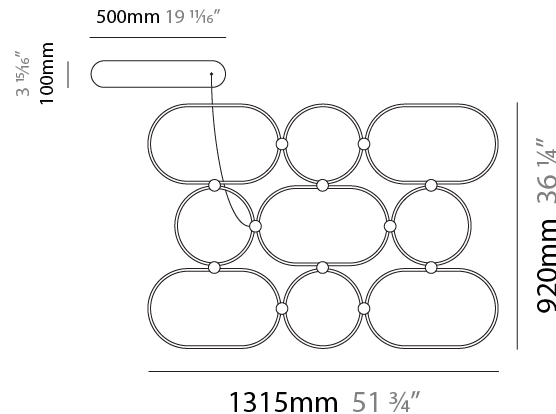
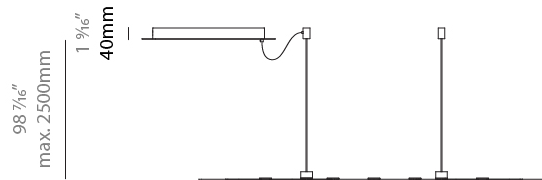

D41104-

PROJECT \_\_\_\_\_

TYPE \_\_\_\_\_

SPECIFIER \_\_\_\_\_

QUANTITY \_\_\_\_\_

DATE \_\_\_\_\_

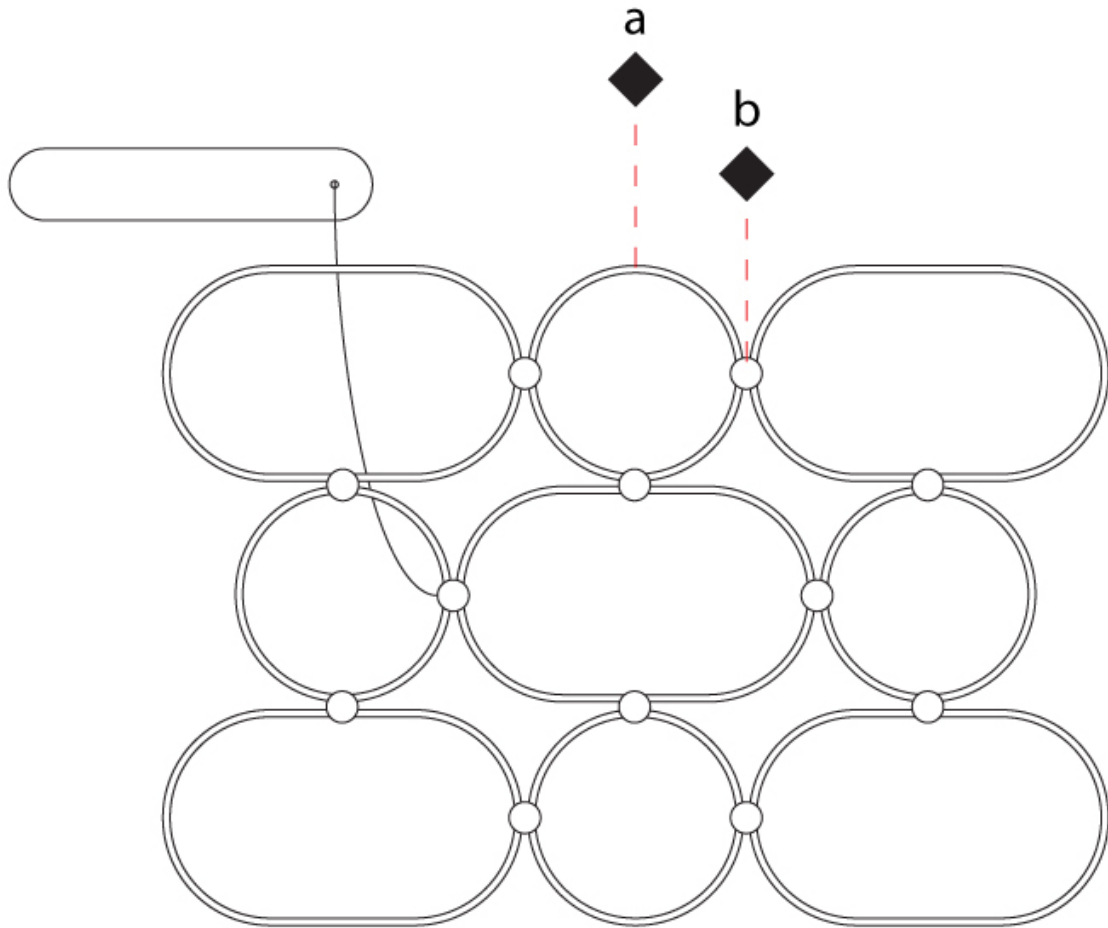

D

PROJECT	_____
TYPE	_____
SPECIFIER	_____
QUANTITY	_____
DATE	_____

## NONAME SURFACE

### D42093-

base number	LED	Color	Finish
	Dimming	Temperature	Options

- To build a product code in our configurator select the specify button on the base model # product page
- To build a manual product code on this datasheet choose from the options listed below in blue font and add the suffix to the base model #

#### GENERAL

Series: NoName
Partner: Icone
Division: Design
Installation: Surface
Product Type: Ceiling Surface
Mounting Location: Ceiling
Light Distribution: Direct / Indirect

#### PHYSICAL

Shape: Abstract
Length (mm): 1315
Length (in): 51 3/4
Width (mm): 300
Width (in): 11 13/16
Height (mm): 30
Height (in): 1 3/16
Fixture Finish: <a href="#">BLK</a> / <a href="#">WHB</a> / <a href="#">WHW</a> / <a href="#">BKB</a> / <a href="#">BRA</a> / <a href="#">SBS</a>
Fixture Material: Aluminum

#### ELECTRICAL

Lamp Type: LED
Input Wattage (W): 41.6
Dimming: <a href="#">Phase Dimming</a> / <a href="#">0-10V Dimming</a>
Driver Included: Yes
Driver Location: Integrated
Driver Class: Class 2
Input Voltage (V): 120 - 277
Output Voltage (V): 24

#### LED

Color Temperature (°K): <a href="#">2700</a> / <a href="#">3000</a>
Max. Delivered Lumen (lm): 5700 / 5800
CRI: >80 CRI
Lamp Life (hrs): 50000

#### OPTICAL

#### RATINGS AND CERTIFICATIONS

Certified By: Certified for North American Standards
IP rating: IP20

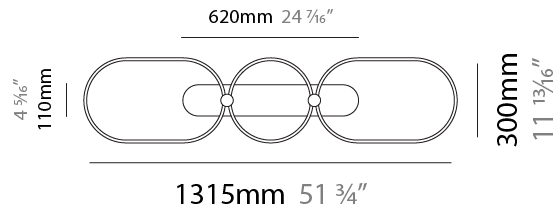
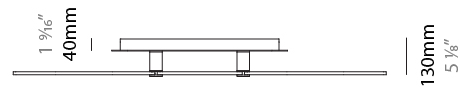

D42093-

PROJECT	_____
TYPE	_____
SPECIFIER	_____
QUANTITY	_____
DATE	_____

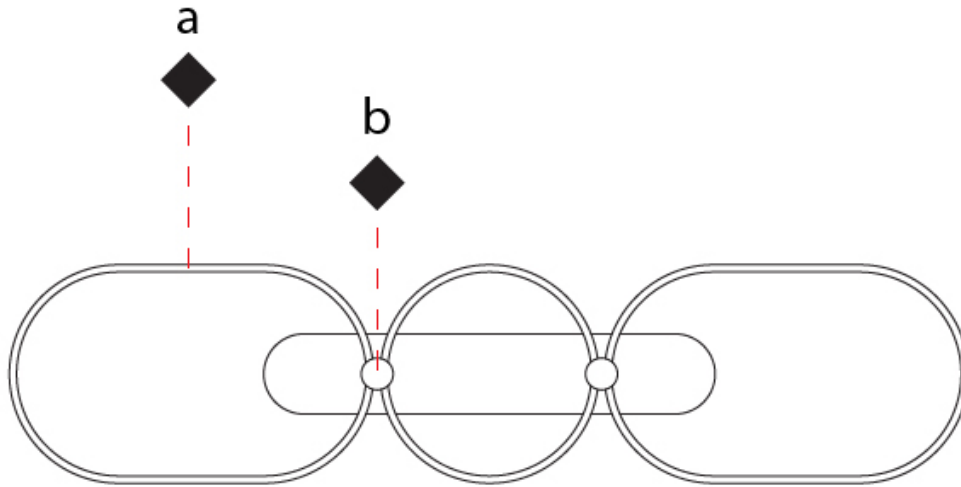

## NONAME SURFACE

### D42094-

base number    LED    Color    Finish  
 Dimming    Temperature    Options

- To build a product code in our configurator select the specify button on the base model # product page
- To build a manual product code on this datasheet choose from the options listed below in blue font and add the suffix to the base model #

#### GENERAL

Series: NoName  
 Partner: Icone  
 Division: Design  
 Installation: Surface  
 Product Type: Ceiling Surface  
 Mounting Location: Ceiling  
 Light Distribution: Direct / Indirect

#### PHYSICAL

Shape: Abstract  
 Length (mm): 910  
 Length (in): 35 <sup>13</sup>/<sub>16</sub>"  
 Width (mm): 605  
 Width (in): 23 <sup>13</sup>/<sub>16</sub>"  
 Height (mm): 30  
 Height (in): 1 <sup>3</sup>/<sub>16</sub>"  
[Fixture Finish: BLK / WHB / WHW / BKB / BRA / SBS](#)  
 Fixture Material: Aluminum

#### ELECTRICAL

Lamp Type: LED  
 Input Wattage (W): 51  
[Dimming: Phase Dimming / 0-10V Dimming](#)  
 Driver Included: Yes  
 Driver Location: Integrated  
 Driver Class: Class 2  
 Input Voltage (V): 120 - 277  
 Output Voltage (V): 24

#### LED

[Color Temperature \(°K\): 2700 / 3000](#)  
 Max. Delivered Lumen (lm): 7050 / 7270  
 CRI: >80 CRI  
 Lamp Life (hrs): 50000

#### OPTICAL

#### RATINGS AND CERTIFICATIONS

Certified By: Certified for North American Standards  
 IP rating: IP20

PROJECT
TYPE
SPECIFIER
QUANTITY
DATE

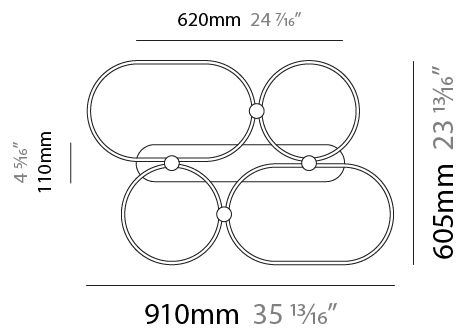

PROJECT

TYPE

SPECIFIER

QUANTITY

DATE

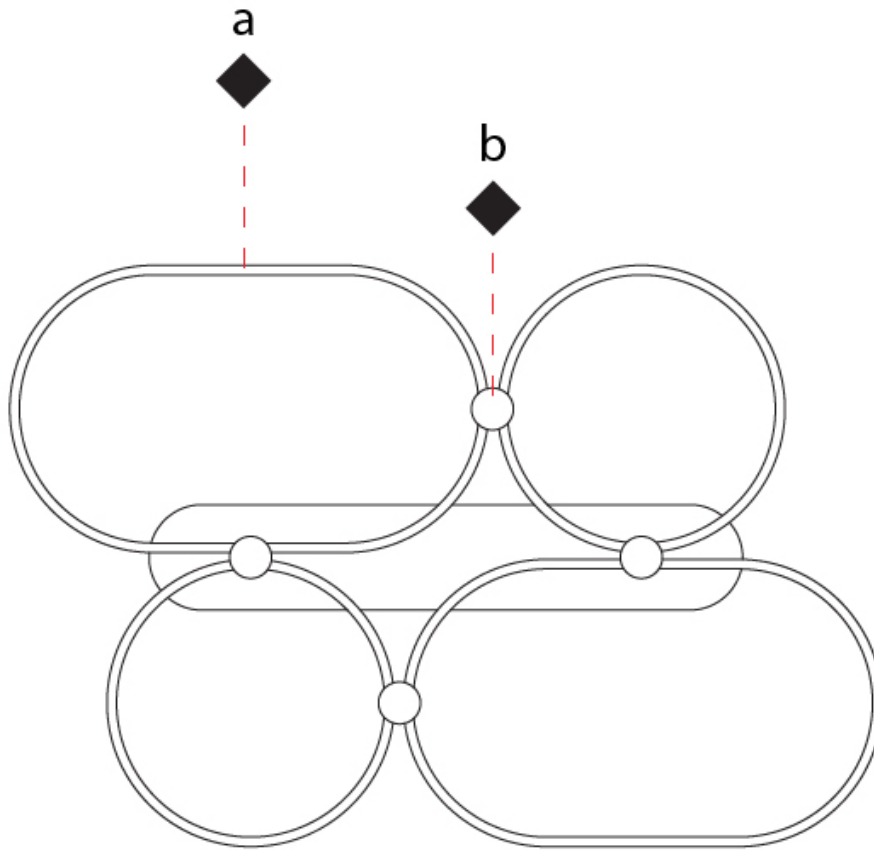

## NONAME SURFACE

### D42095-

base number    LED    Color    Finish  
 Dimming    Temperature    Options

- To build a product code in our configurator select the specify button on the base model # product page
- To build a manual product code on this datasheet choose from the options listed below in blue font and add the suffix to the base model #

#### GENERAL

Series: NoName  
 Partner: Icone  
 Division: Design  
 Installation: Surface  
 Product Type: Ceiling Surface  
 Mounting Location: Ceiling  
 Light Distribution: Direct / Indirect

#### PHYSICAL

Shape: Abstract  
 Length (mm): 1315  
 Length (in): 51 <sup>3</sup>/<sub>4</sub>  
 Width (mm): 920  
 Width (in): 36 <sup>1</sup>/<sub>4</sub>  
 Height (mm): 30  
 Height (in): 1 <sup>3</sup>/<sub>16</sub>  
 Fixture Finish: [BLK](#) / [WHB](#) / [WHW](#) / [BKB](#) / [BRA](#) / [SBS](#)  
 Fixture Material: Aluminum

#### ELECTRICAL

Lamp Type: LED  
 Input Wattage (W): 116  
 Dimming: [Phase Dimming](#) / [0-10V Dimming](#)  
 Driver Included: Yes  
 Driver Location: Integrated  
 Driver Class: Class 2  
 Input Voltage (V): 120 - 277  
 Output Voltage (V): 24

#### LED

[Color Temperature \(°K\): 2700 / 3000](#)  
 Max. Delivered Lumen (lm): 15900 / 16500  
 CRI: >80 CRI  
 Lamp Life (hrs): 50000

#### OPTICAL

#### RATINGS AND CERTIFICATIONS

Certified By: Certified for North American Standards  
 IP rating: IP20

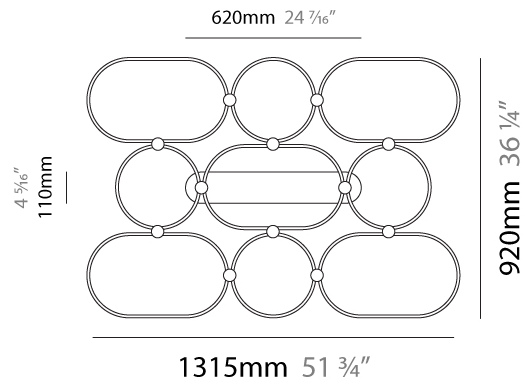
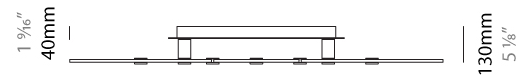

D42095-

PROJECT	_____
TYPE	_____
SPECIFIER	_____
QUANTITY	_____
DATE	_____

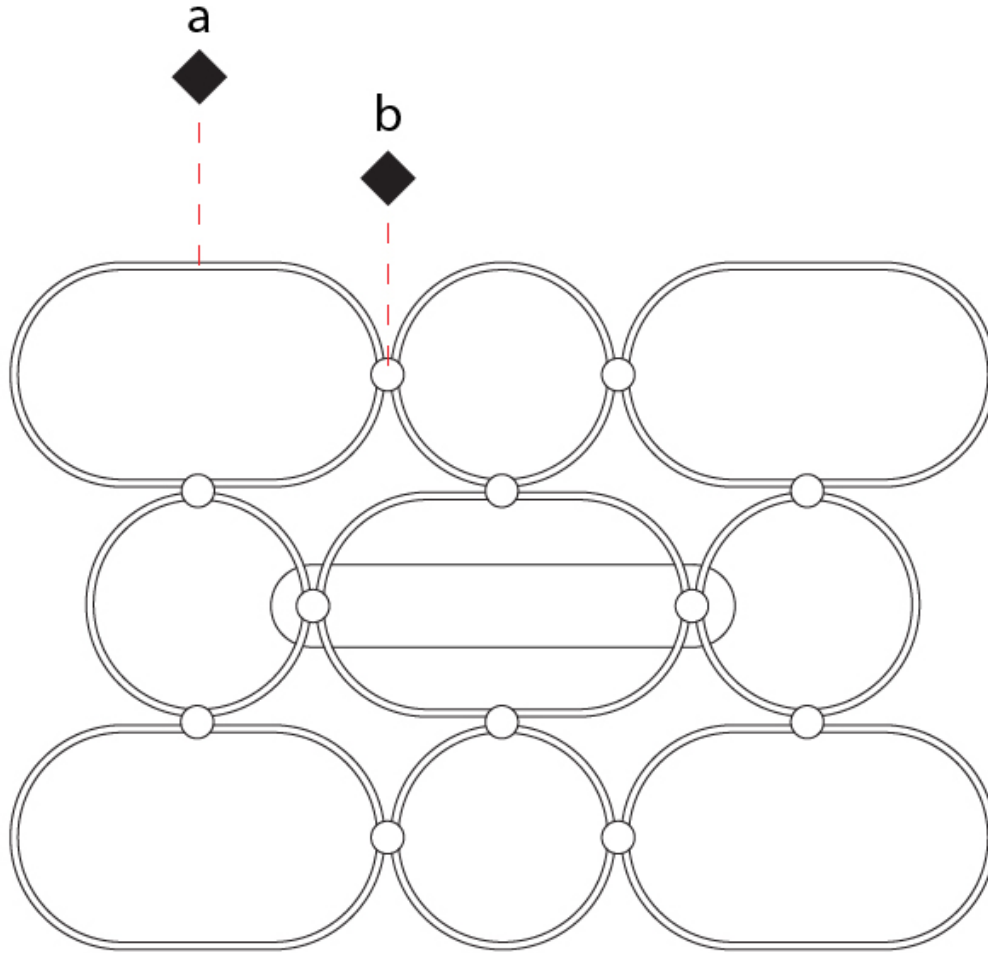

D

PROJECT	_____
TYPE	_____
SPECIFIER	_____
QUANTITY	_____
DATE	_____

## NONAME SURFACE

### D42096-

base number	LED	Color	Finish
	Dimming	Temperature	Options

- To build a product code in our configurator select the specify button on the base model # product page
- To build a manual product code on this datasheet choose from the options listed below in blue font and add the suffix to the base model #

#### GENERAL

Series: NoName
Partner: Icone
Division: Design
Installation: Surface
Product Type: Ceiling Surface
Mounting Location: Ceiling
Light Distribution: Direct

#### PHYSICAL

Shape: Abstract
Length (mm): 1315
Length (in): 51 3/4
Width (mm): 300
Width (in): 11 13/16
Height (mm): 30
Height (in): 1 3/16
Fixture Finish: <a href="#">BLK</a> / <a href="#">WHB</a> / <a href="#">WHW</a> / <a href="#">BKB</a> / <a href="#">BRA</a> / <a href="#">SBS</a>
Fixture Material: Aluminum

#### ELECTRICAL

Lamp Type: LED
Input Wattage (W): 41.6
Dimming: <a href="#">Phase Dimming</a> / <a href="#">0-10V Dimming</a>
Driver Included: Yes
Driver Class: Class 2
Input Voltage (V): 120 - 277
Output Voltage (V): 24

#### LED

Color Temperature (°K): <a href="#">2700</a> / <a href="#">3000</a>
Max. Delivered Lumen (lm): 5700 / 5800
CRI: >80 CRI
Lamp Life (hrs): 50000

#### OPTICAL

#### RATINGS AND CERTIFICATIONS

Certified By: Certified for North American Standards
IP rating: IP20

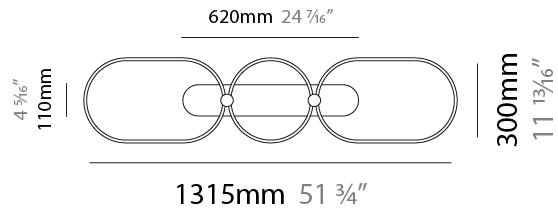
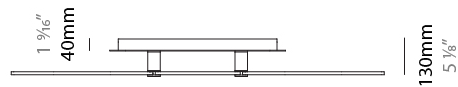

D42096-

PROJECT	_____
TYPE	_____
SPECIFIER	_____
QUANTITY	_____
DATE	_____

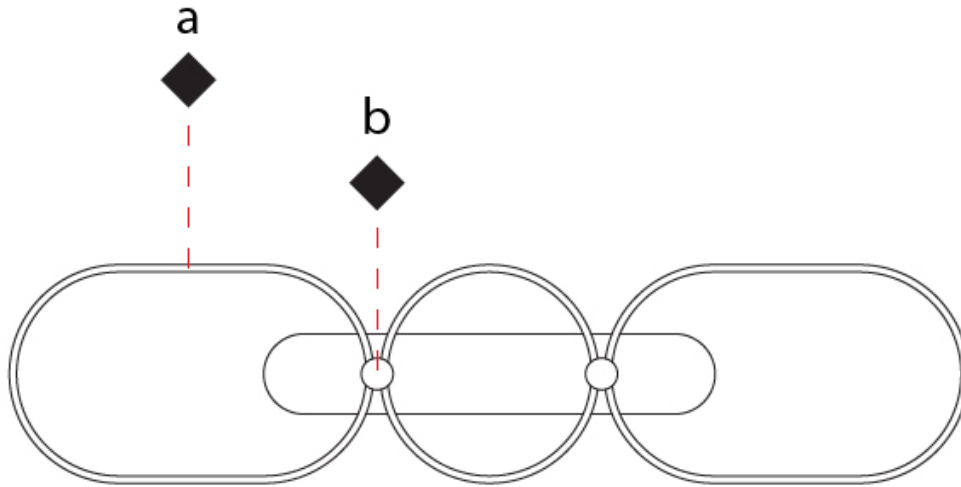

## NONAME SURFACE

### D42097-

base number    LED    Color    Finish  
 Dimming    Temperature    Options

- To build a product code in our configurator select the specify button on the base model # product page
- To build a manual product code on this datasheet choose from the options listed below in blue font and add the suffix to the base model #

#### GENERAL

Series: NoName  
 Partner: Icone  
 Division: Design  
 Installation: Surface  
 Product Type: Ceiling Surface  
 Mounting Location: Ceiling  
 Light Distribution: Direct

#### PHYSICAL

Shape: Abstract  
 Length (mm): 910  
 Length (in): 35 <sup>13</sup>/<sub>16</sub>"  
 Width (mm): 605  
 Width (in): 23 <sup>13</sup>/<sub>16</sub>"  
 Height (mm): 30  
 Height (in): 1 <sup>3</sup>/<sub>16</sub>"  
[Fixture Finish: BLK / WHB / WHW / BKB / BRA / SBS](#)  
 Fixture Material: Aluminum

#### ELECTRICAL

Lamp Type: LED  
 Input Wattage (W): 51  
[Dimming: Phase Dimming / 0-10V Dimming](#)  
 Driver Included: Yes  
 Driver Location: Integrated  
 Driver Class: Class 2  
 Input Voltage (V): 120 - 277  
 Output Voltage (V): 24

#### LED

[Color Temperature \(°K\): 2700 / 3000](#)  
 Max. Delivered Lumen (lm): 7050 / 7270  
 CRI: >80 CRI  
 Lamp Life (hrs): 50000

#### OPTICAL

#### RATINGS AND CERTIFICATIONS

Certified By: Certified for North American Standards  
 IP rating: IP20

PROJECT
TYPE
SPECIFIER
QUANTITY
DATE

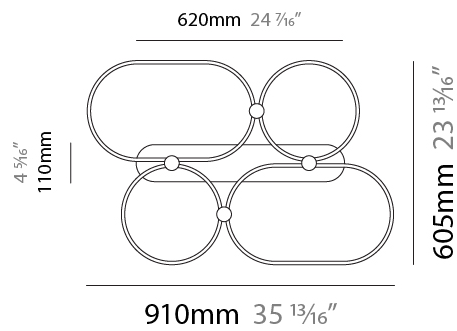

PROJECT	_____
TYPE	_____
SPECIFIER	_____
QUANTITY	_____
DATE	_____

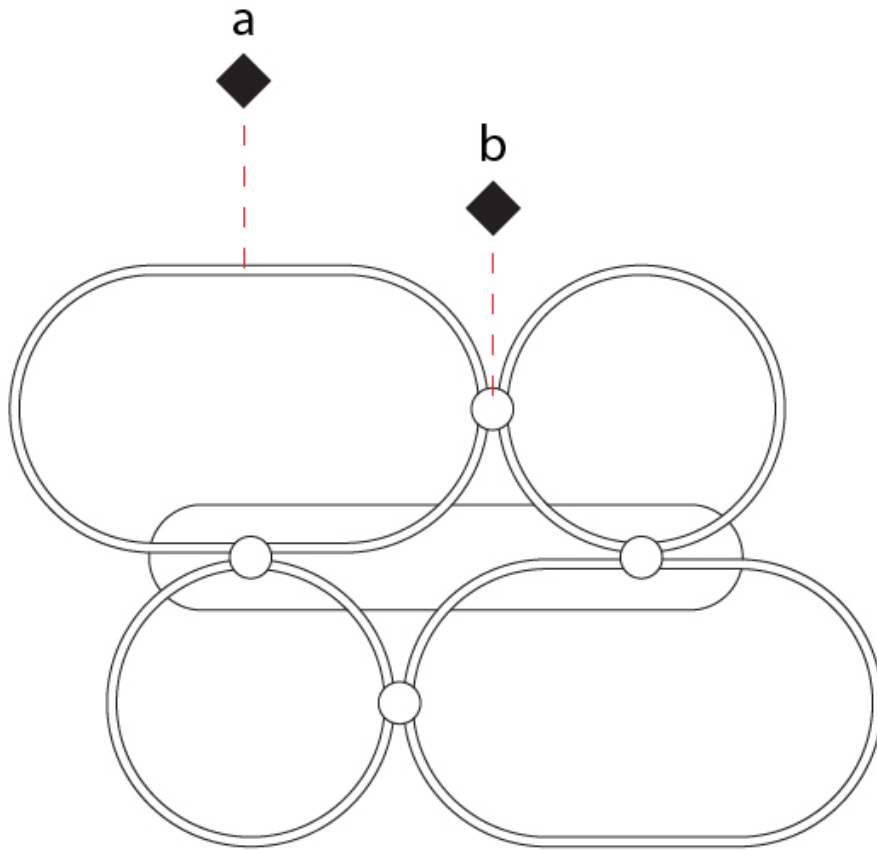

## NONAME SURFACE

### D42097- : D42097-DV-30K-BLK

base number LED Dimming Color Temperature Finish Options

- To build a product code in our configurator select the specify button on the base model # product page
- To build a manual product code on this datasheet choose from the options listed below in blue font and add the suffix to the base model #

#### GENERAL

Series: NoName  
 Partner: Icone  
 Division: Design  
 Installation: Surface  
 Product Type: Ceiling Surface  
 Mounting Location: Ceiling  
 Light Distribution: Direct

#### PHYSICAL

Shape: Abstract  
 Length (mm): 910  
 Length (in): 35 <sup>13</sup>/<sub>16</sub>"  
 Width (mm): 605  
 Width (in): 23 <sup>13</sup>/<sub>16</sub>"  
 Height (mm): 30  
 Height (in): 1 <sup>3</sup>/<sub>16</sub>"  
 Fixture Finish: [BLK](#) / [WHB](#) / [WHW](#) / [BKB](#) / [BRA](#) / [SBS](#)  
 Fixture Material: Aluminum

#### ELECTRICAL

Lamp Type: LED  
 Input Wattage (W): 51  
 Dimming: [Phase Dimming](#) / [0-10V Dimming](#)  
 Driver Included: Yes  
 Driver Location: Integrated  
 Driver Class: Class 2  
 Input Voltage (V): 120 - 277  
 Output Voltage (V): 24

#### LED

[Color Temperature \(°K\): 2700 / 3000](#)  
 Max. Delivered Lumen (lm): 7050 / 7270  
 CRI: >80 CRI  
 Lamp Life (hrs): 50000

#### OPTICAL

#### RATINGS AND CERTIFICATIONS

Certified By: Certified for North American Standards  
 IP rating: IP20

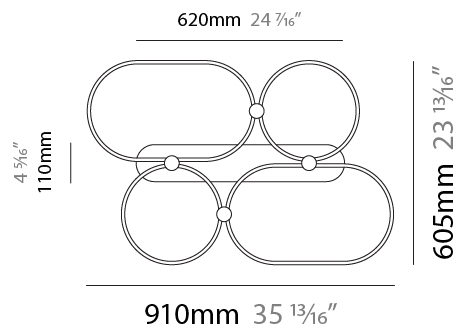
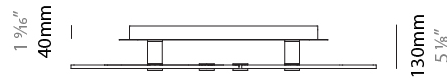

PROJECT	_____
TYPE	_____
SPECIFIER	_____
QUANTITY	_____
DATE	_____

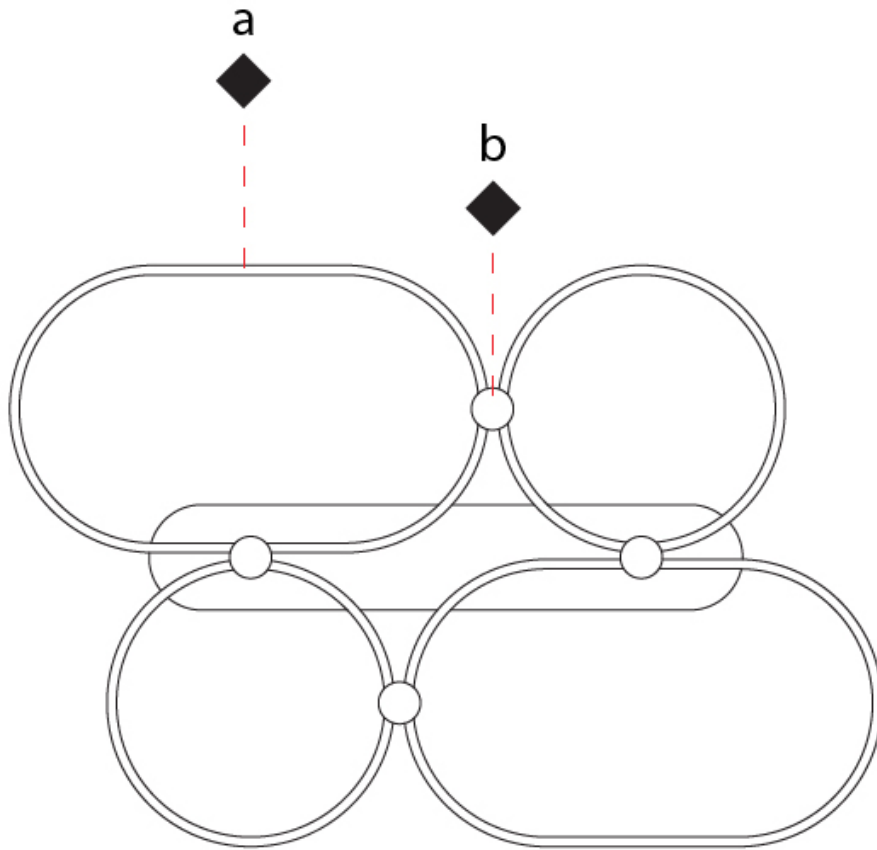

## NONAME SURFACE

### D42098-

base number    LED Dimming    Color Temperature    Finish Options

- To build a product code in our configurator select the specify button on the base model # product page
- To build a manual product code on this datasheet choose from the options listed below in blue font and add the suffix to the base model #

#### GENERAL

Series: NoName  
 Partner: Icone  
 Division: Design  
 Installation: Surface  
 Product Type: Ceiling Surface  
 Mounting Location: Ceiling  
 Light Distribution: Direct

#### PHYSICAL

Shape: Abstract  
 Length (mm): 1315  
 Length (in): 51 <sup>3</sup>/<sub>4</sub>  
 Width (mm): 920  
 Width (in): 36 <sup>1</sup>/<sub>4</sub>  
 Height (mm): 30  
 Height (in): 1 <sup>3</sup>/<sub>16</sub>  
 Fixture Finish: [BLK](#) / [WHB](#) / [WHW](#) / [BKB](#) / [BRA](#) / [SBS](#)  
 Fixture Material: Aluminum

#### ELECTRICAL

Lamp Type: LED  
 Input Wattage (W): 116  
 Dimming: [Phase Dimming](#) / [0-10V Dimming](#)  
 Driver Included: Yes  
 Driver Location: Integrated  
 Driver Class: Class 2  
 Input Voltage (V): 120 - 277  
 Output Voltage (V): 24

#### LED

Color Temperature (°K): [2700](#) / [3000](#)  
 Max. Delivered Lumen (lm): 15900 / 16500  
 CRI: >80 CRI  
 Lamp Life (hrs): 50000

#### OPTICAL

#### RATINGS AND CERTIFICATIONS

Certified By: Certified for North American Standards  
 IP rating: IP20

PROJECT
TYPE
SPECIFIER
QUANTITY
DATE

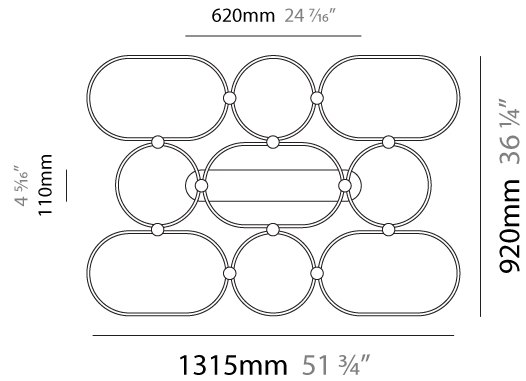
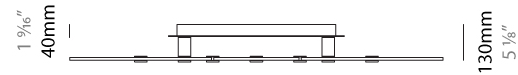

D42098-

PROJECT	_____
TYPE	_____
SPECIFIER	_____
QUANTITY	_____
DATE	_____

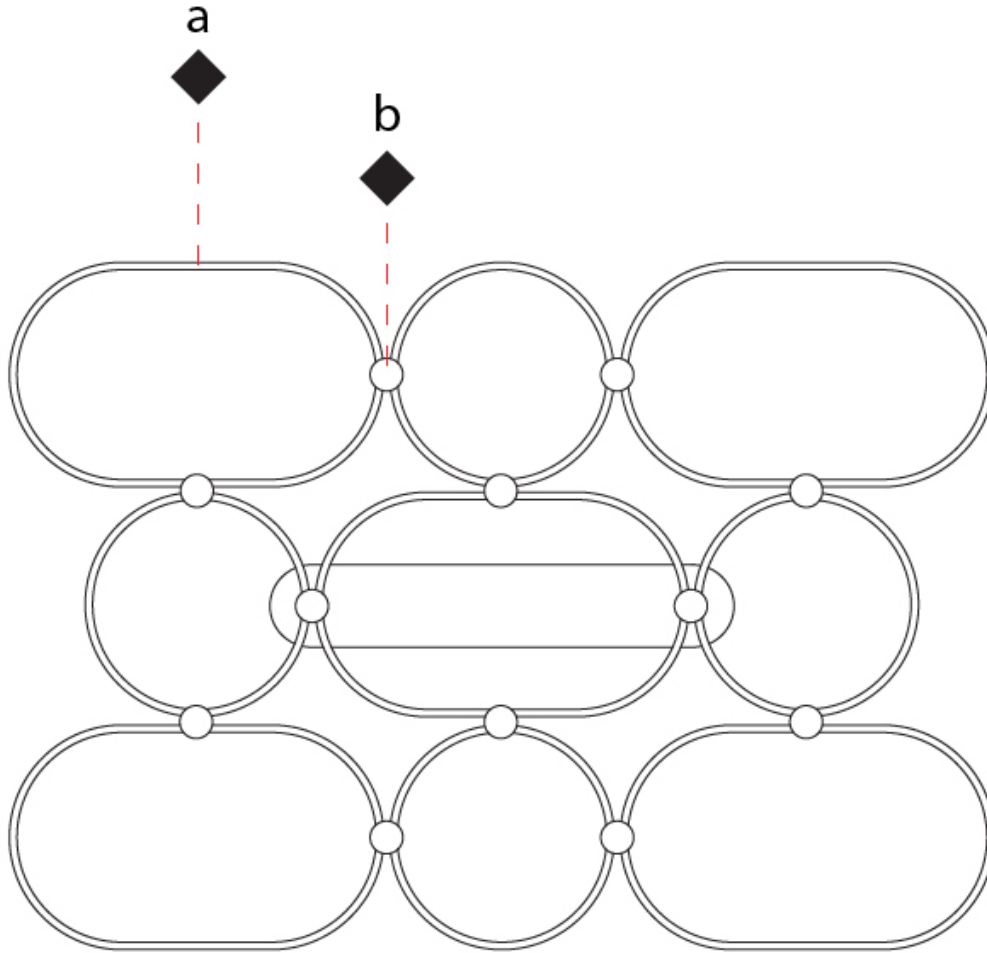

PROJECT	_____
TYPE	_____
SPECIFIER	_____
QUANTITY	_____
DATE	_____

## NONAME SURFACE

### D43086-

base number	LED Dimming	Color Temperature	Finish Options
-------------	----------------	----------------------	-------------------

- To build a product code in our configurator select the specify button on the base model # product page
- To build a manual product code on this datasheet choose from the options listed below in blue font and add the suffix to the base model #

#### GENERAL

Series: NoName
Partner: Icone
Division: Design
Installation: Surface
Product Type: Wall Surface
Mounting Location: Wall
Light Distribution: Indirect

#### PHYSICAL

Shape: Abstract
Length (mm): 300
Length (in): 11 <sup>13</sup> / <sub>16</sub>
Height (mm): 540
Depth (mm): 130
Height (in): 21 <sup>1</sup> / <sub>4</sub>
Depth (in): 5 <sup>1</sup> / <sub>8</sub>
Fixture Finish: <a href="#">BLK</a> / <a href="#">WHB</a> / <a href="#">WHW</a> / <a href="#">BKB</a> / <a href="#">BRA</a> / <a href="#">SBS</a>
Fixture Material: Aluminum

#### ELECTRICAL

Lamp Type: LED
Input Wattage (W): 15.6
Dimming: <a href="#">Phase Dimming</a> / <a href="#">0-10V Dimming</a>
Driver Included: Yes
Driver Location: Integrated
Driver Class: Class 2
Input Voltage (V): 120 - 277
Output Voltage (V): 24

#### LED

Color Temperature (°K): <a href="#">2700</a> / <a href="#">3000</a>
Max. Delivered Lumen (lm): 2140 / 2200
CRI: >80 CRI
Lamp Life (hrs): 50000

#### OPTICAL

#### RATINGS AND CERTIFICATIONS

Certified By: Certified for North American Standards
IP rating: IP20

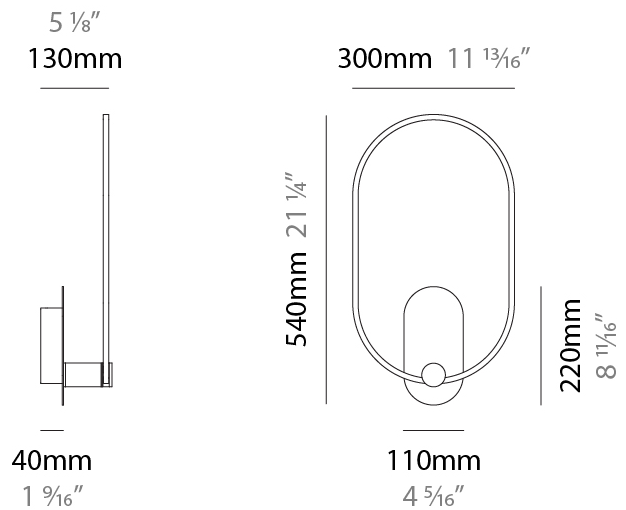
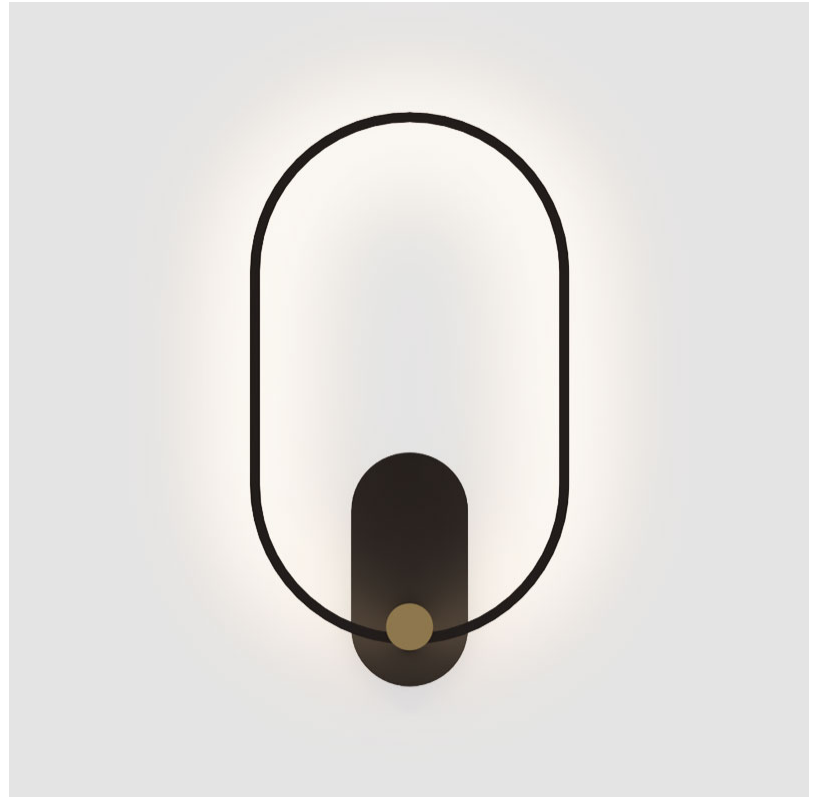

D43086-

PROJECT

TYPE

SPECIFIER

QUANTITY

DATE

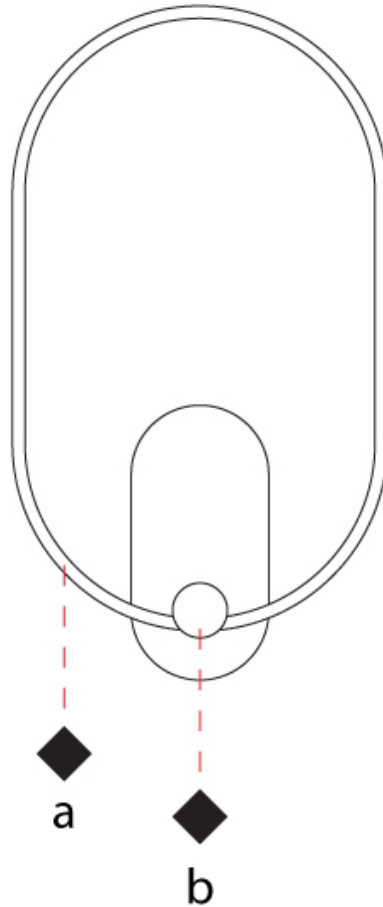

D

## NONAME SURFACE

### D43087-

base number    LED Dimming    Color Temperature    Finish Options

- To build a product code in our configurator select the specify button on the base model # product page
- To build a manual product code on this datasheet choose from the options listed below in blue font and add the suffix to the base model #

#### GENERAL

Series: NoName  
 Partner: Icone  
 Division: Design  
 Installation: Surface  
 Product Type: Wall Surface  
 Mounting Location: Wall  
 Light Distribution: Indirect

#### PHYSICAL

Shape: Abstract  
 Length (mm): 300  
 Length (in): 11 <sup>13</sup>/<sub>16</sub>  
 Height (mm): 810  
 Depth (mm): 130  
 Height (in): 31 <sup>7</sup>/<sub>8</sub>  
 Depth (in): 5 <sup>1</sup>/<sub>8</sub>  
 Fixture Finish: [BLK](#) / [WHB](#) / [WHW](#) / [BKB](#) / [BRA](#) / [SBS](#)  
 Fixture Material: Aluminum

#### ELECTRICAL

Lamp Type: LED  
 Input Wattage (W): 26  
 Dimming: [Phase Dimming](#) / [0-10V Dimming](#)  
 Driver Included: Yes  
 Driver Location: Integrated  
 Driver Class: Class 2  
 Input Voltage (V): 120 - 277  
 Output Voltage (V): 24

#### LED

Color Temperature (°K): [2700](#) / [3000](#)  
 Max. Delivered Lumen (lm): 3620 / 3730  
 CRI: >80 CRI  
 Lamp Life (hrs): 50000

#### OPTICAL

#### RATINGS AND CERTIFICATIONS

Certified By: Certified for North American Standards  
 IP rating: IP20

PROJECT \_\_\_\_\_  
 TYPE \_\_\_\_\_  
 SPECIFIER \_\_\_\_\_  
 QUANTITY \_\_\_\_\_  
 DATE \_\_\_\_\_

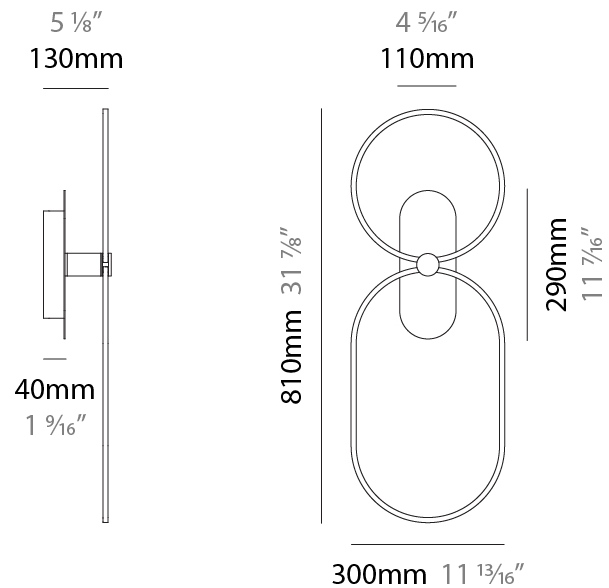

D43087-

PROJECT

TYPE

SPECIFIER

QUANTITY

DATE

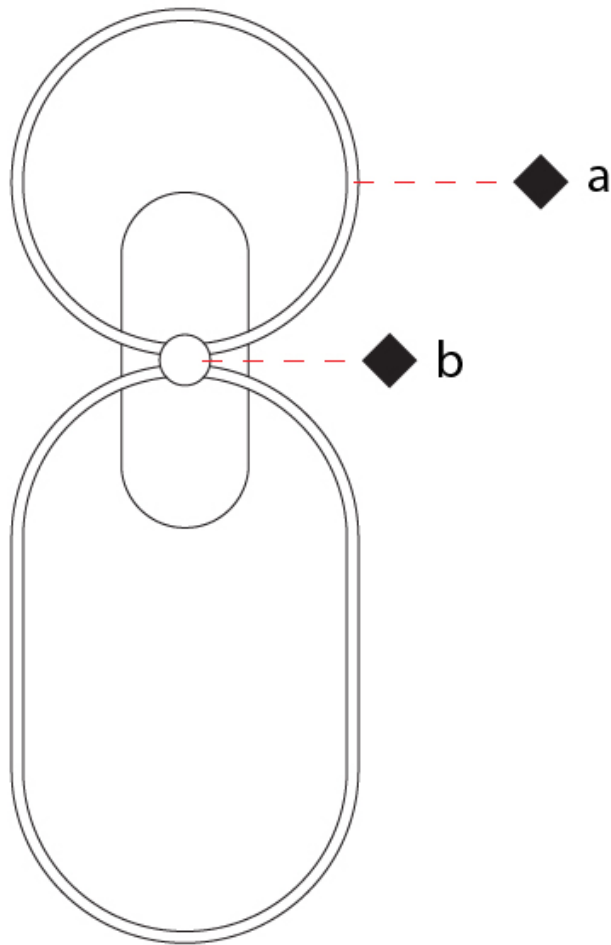

D

## NONAME SURFACE

### D43088-

base number LED Dimming Color Temperature Finish Options

- To build a product code in our configurator select the specify button on the base model # product page
- To build a manual product code on this datasheet choose from the options listed below in blue font and add the suffix to the base model #

#### GENERAL

Series: NoName  
 Partner: Icone  
 Division: Design  
 Installation: Surface  
 Product Type: Wall Surface  
 Mounting Location: Wall  
 Light Distribution: Indirect

#### PHYSICAL

Shape: Abstract  
 Length (mm): 300  
 Length (in): 11 <sup>13</sup>/<sub>16</sub>  
 Height (mm): 1315  
 Depth (mm): 130  
 Height (in): 51 <sup>3</sup>/<sub>4</sub>  
 Depth (in): 5 <sup>1</sup>/<sub>8</sub>  
 Fixture Finish: [BLK](#) / [WHB](#) / [WHW](#) / [BKB](#) / [BRA](#) / [SBS](#)  
 Fixture Material: Aluminum

#### ELECTRICAL

Lamp Type: LED  
 Input Wattage (W): 41.6  
 Dimming: [Phase Dimming](#) / [0-10V Dimming](#)  
 Driver Included: Yes  
 Driver Location: Integrated  
 Driver Class: Class 2  
 Input Voltage (V): 120 - 277  
 Output Voltage (V): 24

#### LED

Color Temperature (°K): [2700](#) / [3000](#)  
 Max. Delivered Lumen (lm): 5700 / 5880  
 CRI: >80 CRI  
 Lamp Life (hrs): 50000

#### OPTICAL

#### RATINGS AND CERTIFICATIONS

Certified By: Certified for North American Standards  
 IP rating: IP20

PROJECT \_\_\_\_\_  
 TYPE \_\_\_\_\_  
 SPECIFIER \_\_\_\_\_  
 QUANTITY \_\_\_\_\_  
 DATE \_\_\_\_\_

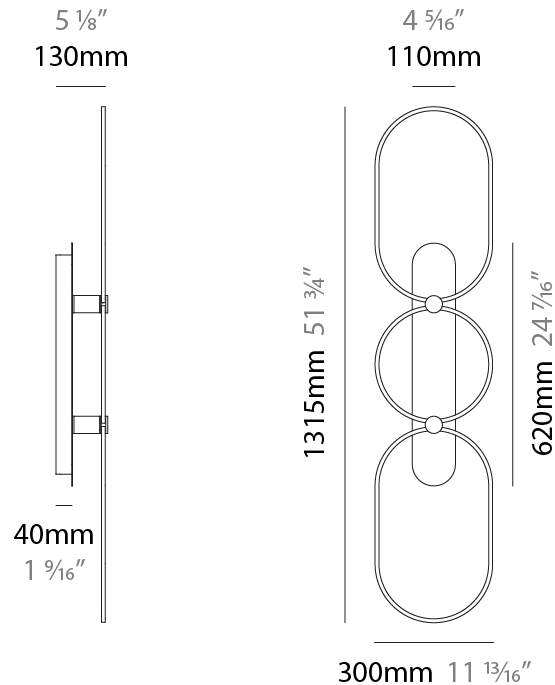
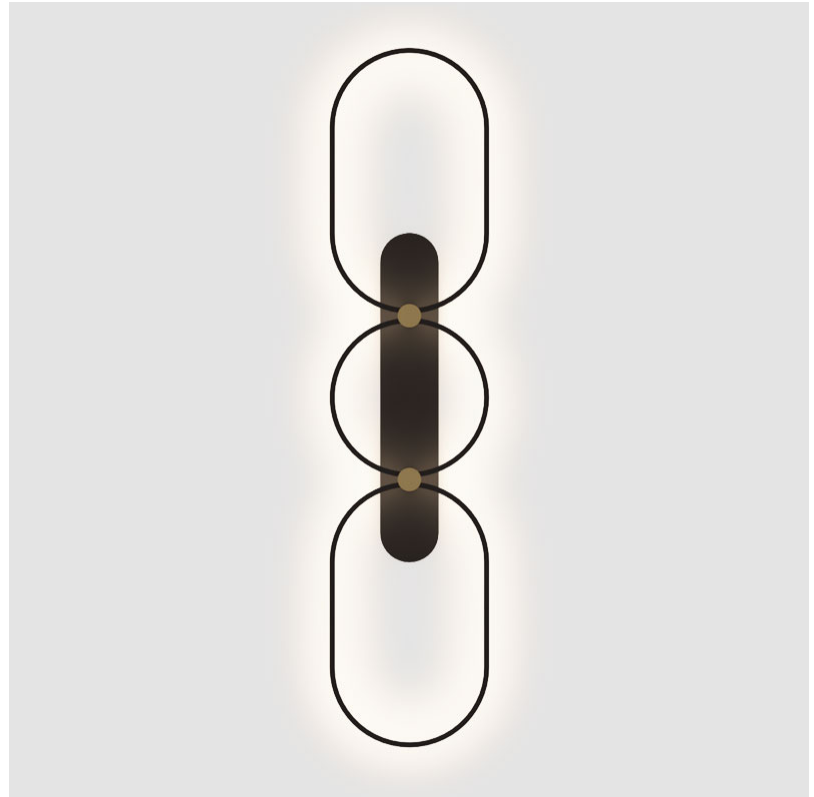

D43088-

PROJECT

TYPE

SPECIFIER

QUANTITY

DATE

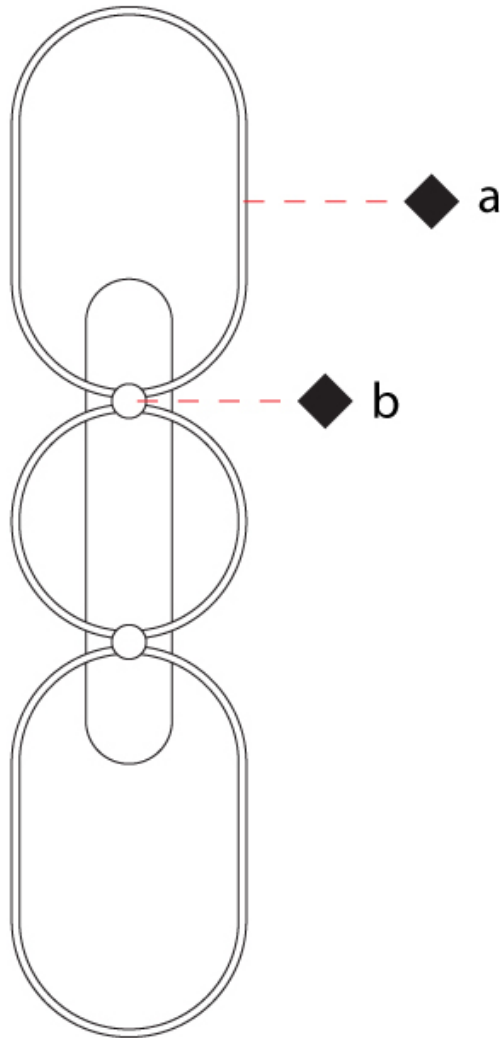

D

PROJECT	
TYPE	
SPECIFIER	
QUANTITY	
DATE	

## NONAME SURFACE

### D43089-

base number	LED Dimming	Color Temperature	Finish Options
-------------	-------------	-------------------	----------------

- To build a product code in our configurator select the specify button on the base model # product page
- To build a manual product code on this datasheet choose from the options listed below in blue font and add the suffix to the base model #

#### GENERAL

Series: NoName
Partner: Icone
Division: Design
Installation: Surface
Product Type: Wall Surface
Mounting Location: Wall
Light Distribution: Indirect

#### PHYSICAL

Shape: Abstract
Length (mm): 605
Length (in): 23 <sup>13</sup> / <sub>16</sub>
Height (mm): 910
Depth (mm): 130
Height (in): 35 <sup>13</sup> / <sub>16</sub>
Depth (in): 5 <sup>1</sup> / <sub>8</sub>
Fixture Finish: <a href="#">BLK</a> / <a href="#">WHB</a> / <a href="#">WHW</a> / <a href="#">BKB</a> / <a href="#">BRA</a> / <a href="#">SBS</a>
Fixture Material: Aluminum

#### ELECTRICAL

Lamp Type: LED
Input Wattage (W): 41.6
Dimming: <a href="#">Phase Dimming</a> / <a href="#">0-10V Dimming</a>
Driver Included: Yes
Driver Location: Integrated
Driver Class: Class 2
Input Voltage (V): 120 - 277
Output Voltage (V): 24

#### LED

Color Temperature (°K): <a href="#">2700</a> / <a href="#">3000</a>
Max. Delivered Lumen (lm): 5700 / 5880
CRI: >80 CRI
Lamp Life (hrs): 50000

#### OPTICAL

#### RATINGS AND CERTIFICATIONS

Certified By: Certified for North American Standards
IP rating: IP20

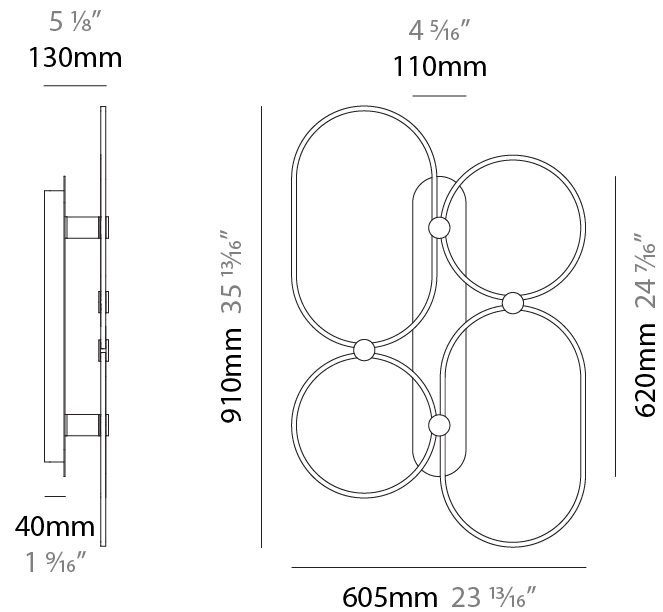
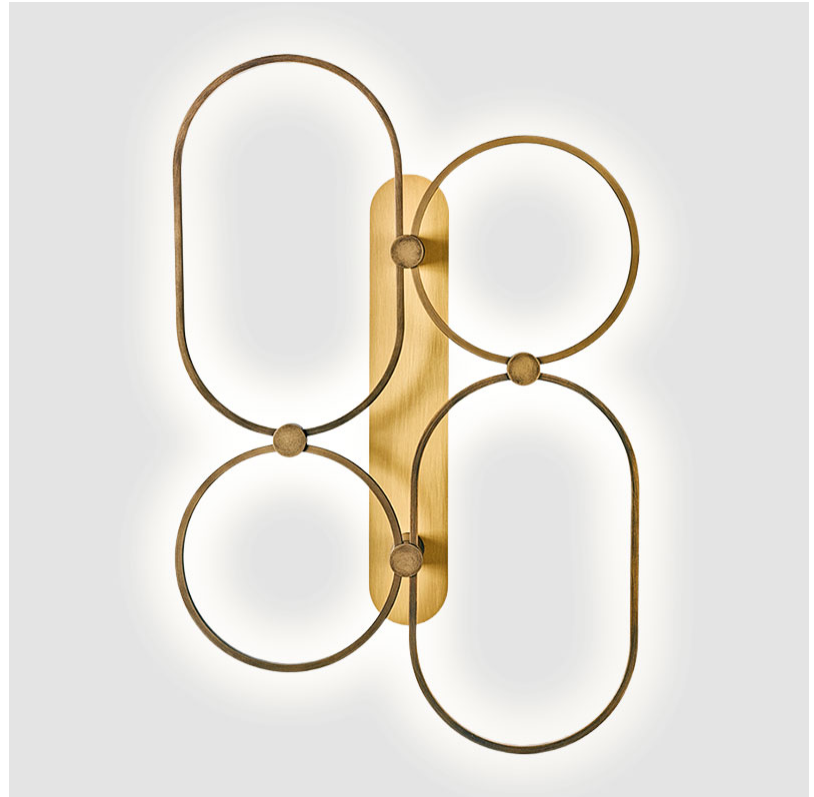

D43089-

PROJECT	_____
TYPE	_____
SPECIFIER	_____
QUANTITY	_____
DATE	_____

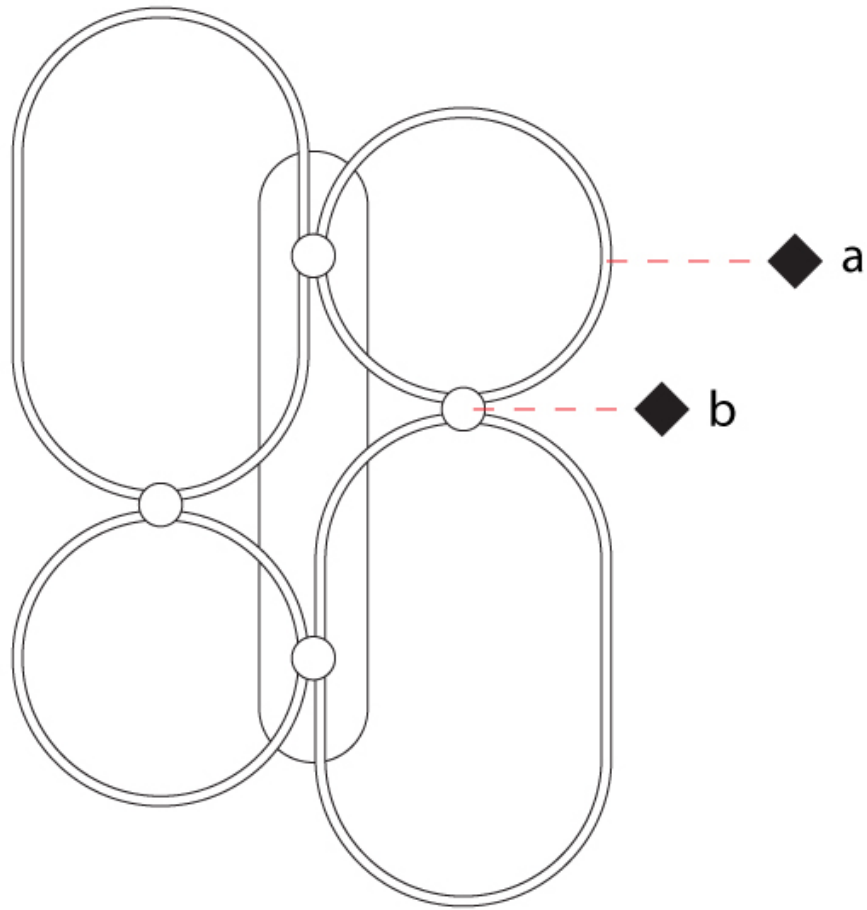

D

## NONAME SURFACE

### D43090-

base number    LED    Color    Finish  
 Dimming    Temperature    Options

- To build a product code in our configurator select the specify button on the base model # product page
- To build a manual product code on this datasheet choose from the options listed below in blue font and add the suffix to the base model #

#### GENERAL

Series: NoName  
 Partner: Icone  
 Division: Design  
 Installation: Surface  
 Product Type: Wall Surface  
 Mounting Location: Wall  
 Light Distribution: Indirect

#### PHYSICAL

Shape: Abstract  
 Length (mm): 920  
 Length (in): 36 1/4  
 Height (mm): 1315  
 Depth (mm): 130  
 Height (in): 51 3/4  
 Depth (in): 5 1/8  
 Fixture Finish: [BLK](#) / [WHB](#) / [WHW](#) / [BKB](#) / [BRA](#) / [SBS](#)  
 Fixture Material: Aluminum

#### ELECTRICAL

Lamp Type: LED  
 Input Wattage (W): 116  
 Dimming: [Phase Dimming](#) / [0-10V Dimming](#)  
 Driver Included: Yes  
 Driver Location: Integrated  
 Driver Class: Class 2  
 Input Voltage (V): 120 - 277  
 Output Voltage (V): 24

#### LED

Color Temperature (°K): [2700](#) / [3000](#)  
 Max. Delivered Lumen (lm): 15900 / 16500  
 CRI: >80 CRI  
 Lamp Life (hrs): 50000

#### OPTICAL

#### RATINGS AND CERTIFICATIONS

Certified By: Certified for North American Standards  
 IP rating: IP20

PROJECT
TYPE
SPECIFIER
QUANTITY
DATE

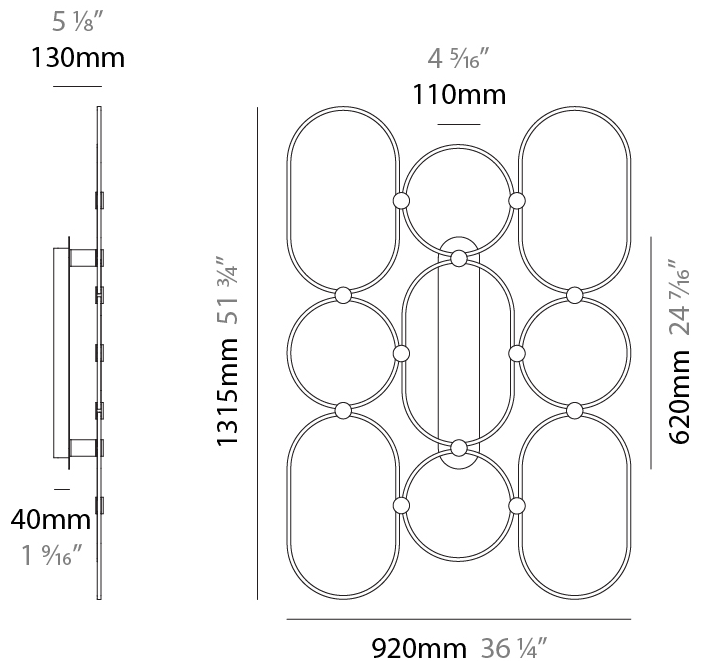
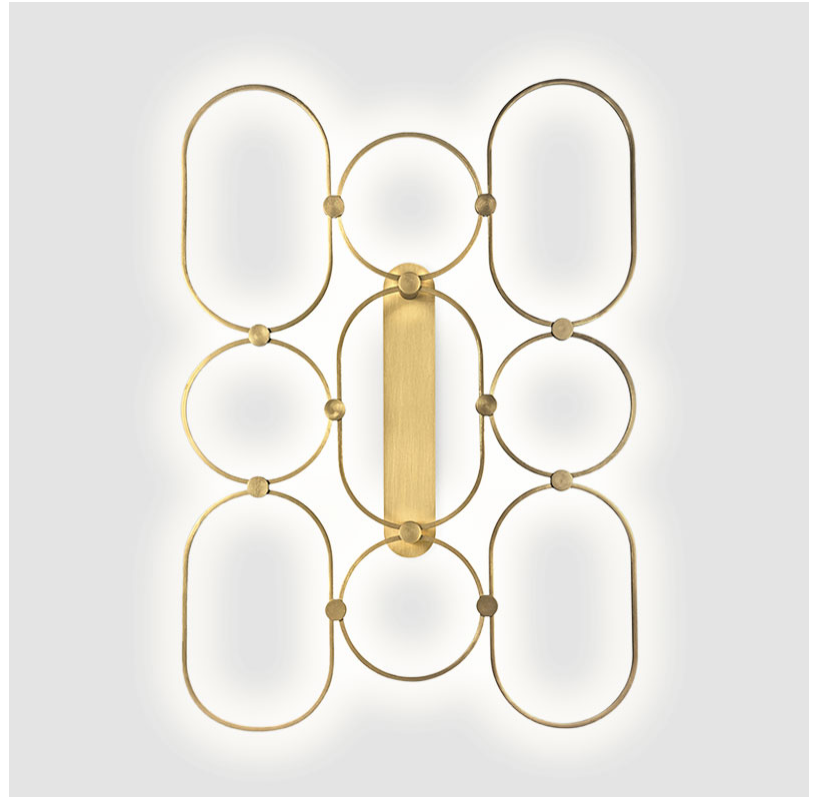

PROJECT	_____
TYPE	_____
SPECIFIER	_____
QUANTITY	_____
DATE	_____

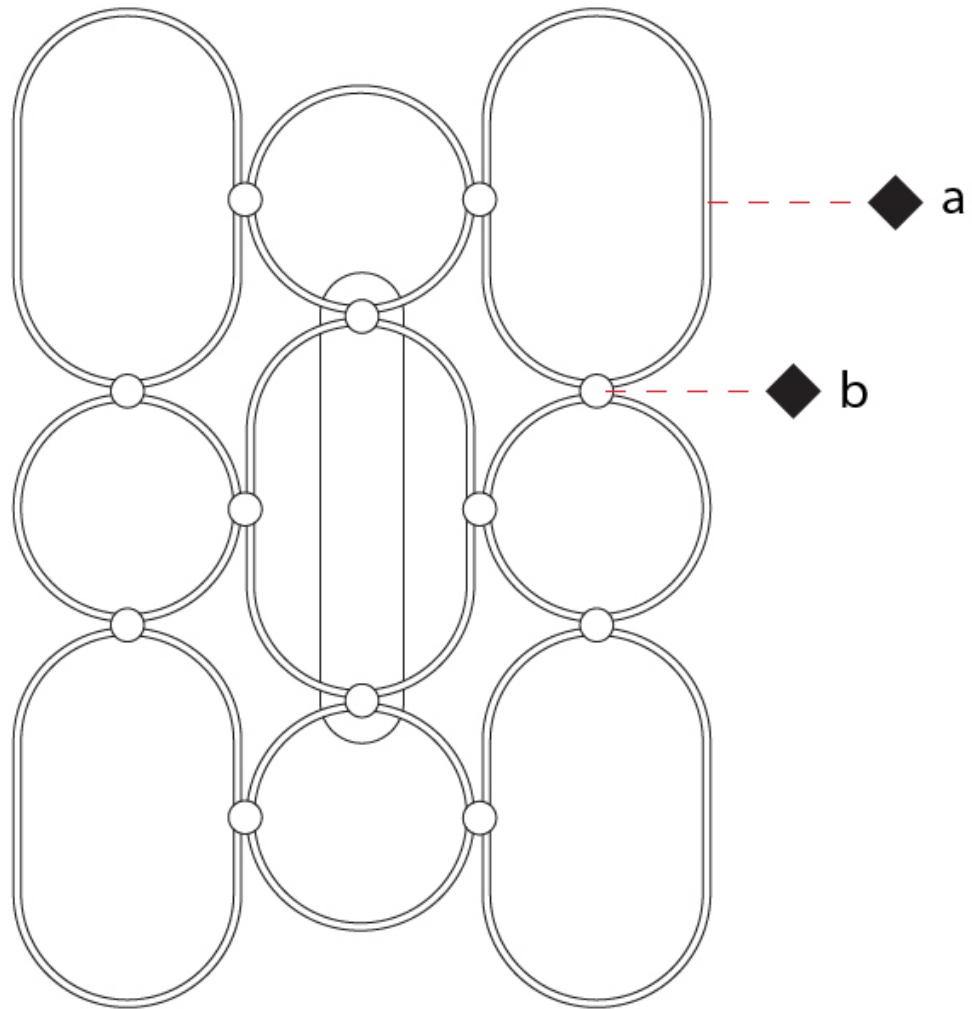

D

PROJECT \_\_\_\_\_  
 TYPE \_\_\_\_\_  
 SPECIFIER \_\_\_\_\_  
 QUANTITY \_\_\_\_\_  
 DATE \_\_\_\_\_

## NONAME SURFACE

**D43091-** \_\_\_\_\_  
 base number    LED    Color    Finish  
                          Dimming    Temperature    Options

- To build a product code in our configurator select the specify button on the base model # product page
- To build a manual product code on this datasheet choose from the options listed below in blue font and add the suffix to the base model #

### GENERAL

Series: NoName  
 Partner: Icone  
 Division: Design  
 Installation: Surface  
 Product Type: Wall Surface  
 Mounting Location: Wall  
 Light Distribution: Indirect

### PHYSICAL

Shape: Abstract  
 Length (mm): 300  
 Length (in): 11 <sup>13</sup>/<sub>16</sub>  
 Height (mm): 505  
 Depth (mm): 130  
 Height (in): 19 <sup>7</sup>/<sub>8</sub>  
 Depth (in): 5 <sup>1</sup>/<sub>8</sub>  
 Fixture Finish: [BLK / WHB / WHW / BKB / BRA / SBS](#)  
 Fixture Material: Aluminum

### ELECTRICAL

Lamp Type: LED  
 Input Wattage (W): 15.6  
 Dimming: [Phase Dimming / 0-10V Dimming](#)  
 Driver Included: No  
 Driver Location: Remote  
 Driver Class: Class 2  
 Input Voltage (V): 120 - 277  
 Output Voltage (V): 24

### LED

Color Temperature (°K): [2700 / 3000](#)  
 Max. Delivered Lumen (lm): 2140 / 2200  
 CRI: >80 CRI  
 Lamp Life (hrs): 50000

### OPTICAL

### RATINGS AND CERTIFICATIONS

Certified By: Certified for North American Standards  
 IP rating: IP20

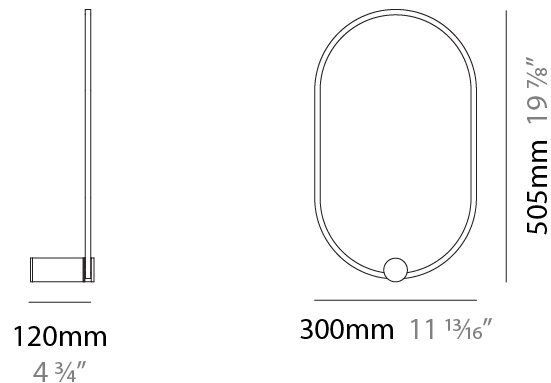

## NONAME SURFACE

D43091-

PROJECT

TYPE

SPECIFIER

QUANTITY

DATE

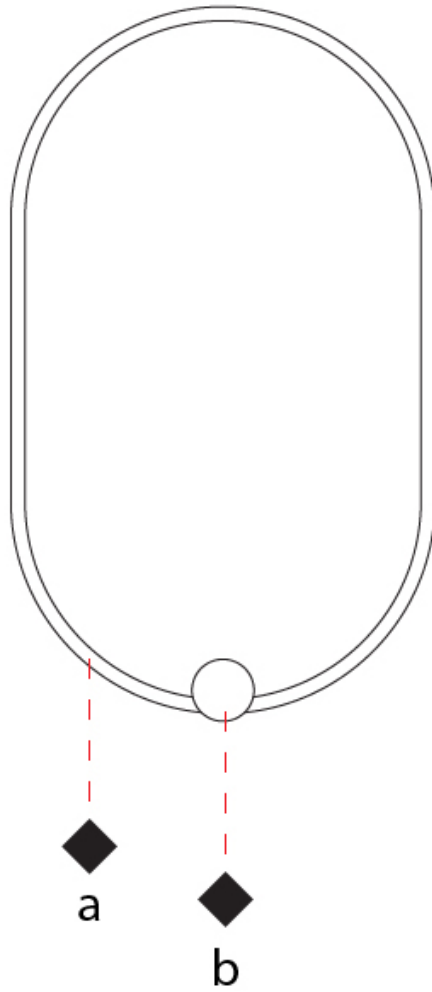

D

## NONAME SURFACE

### D43092-

base number    LED Dimming    Color Temperature    Finish Options

- To build a product code in our configurator select the specify button on the base model # product page
- To build a manual product code on this datasheet choose from the options listed below in blue font and add the suffix to the base model #

#### GENERAL

Series: NoName  
 Partner: Icone  
 Division: Design  
 Installation: Surface  
 Product Type: Wall Surface  
 Mounting Location: Wall  
 Light Distribution: Indirect

#### PHYSICAL

Shape: Abstract  
 Length (mm): 300  
 Length (in): 11 <sup>13</sup>/<sub>16</sub>  
 Height (mm): 810  
 Depth (mm): 130  
 Height (in): 31 <sup>7</sup>/<sub>8</sub>  
 Depth (in): 5 <sup>1</sup>/<sub>8</sub>  
 Fixture Finish: [BLK](#) / [WHB](#) / [WHW](#) / [BKB](#) / [BRA](#) / [SBS](#)  
 Fixture Material: Aluminum

#### ELECTRICAL

Lamp Type: LED  
 Input Wattage (W): 26  
 Dimming: [Phase Dimming](#) / [0-10V Dimming](#)  
 Driver Included: No  
 Driver Location: Remote  
 Driver Class: Class 2  
 Input Voltage (V): 120 - 277  
 Output Voltage (V): 24

#### LED

Color Temperature (°K): [2700](#) / [3000](#)  
 Max. Delivered Lumen (lm): 3620 / 3730  
 CRI: >80 CRI  
 Lamp Life (hrs): 50000

#### OPTICAL

#### RATINGS AND CERTIFICATIONS

Certified By: Certified for North American Standards  
 IP rating: IP20

PROJECT \_\_\_\_\_  
 TYPE \_\_\_\_\_  
 SPECIFIER \_\_\_\_\_  
 QUANTITY \_\_\_\_\_  
 DATE \_\_\_\_\_

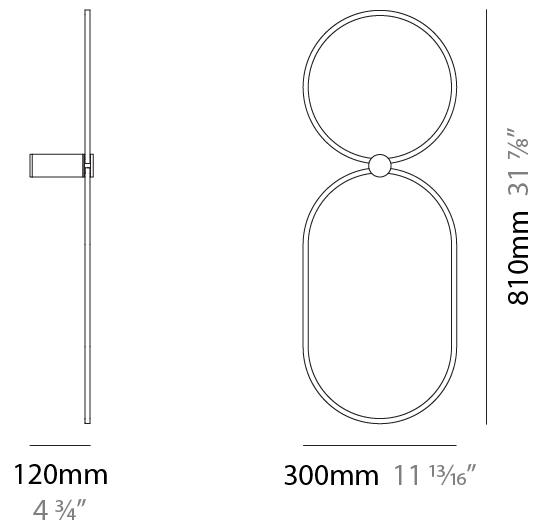
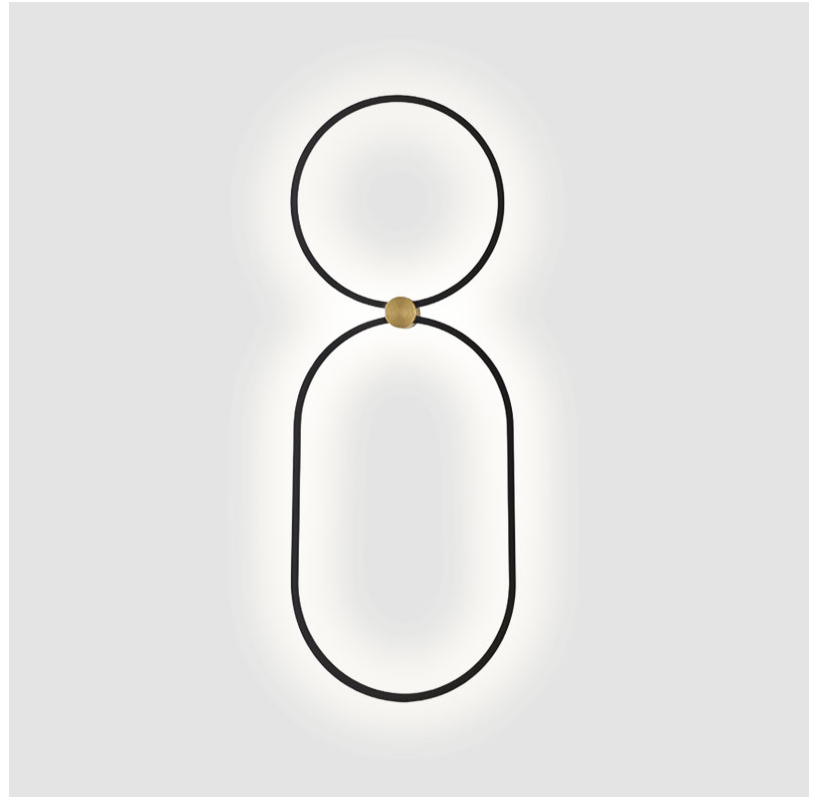

D43092-

PROJECT

TYPE

SPECIFIER

QUANTITY

DATE

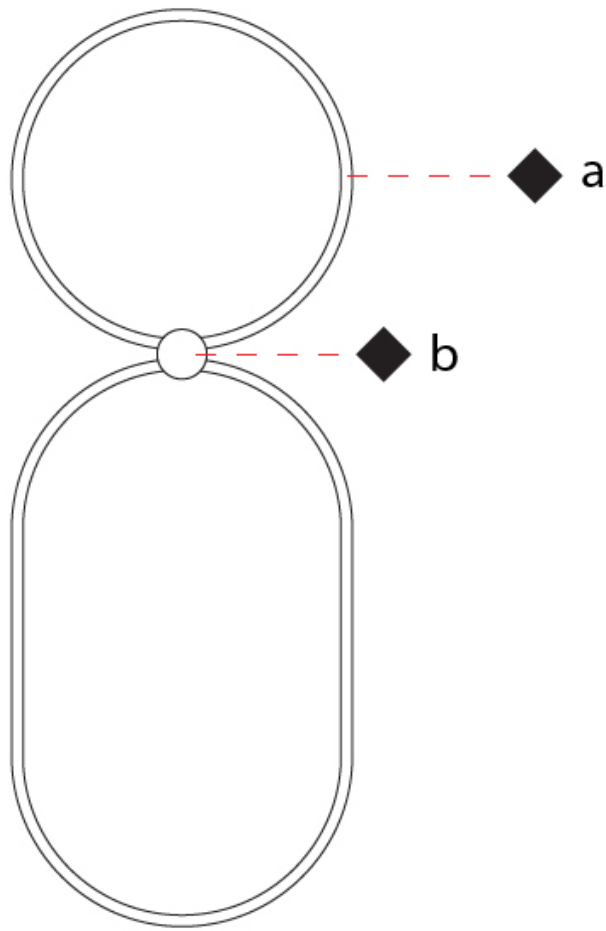

D

## NONAME SURFACE

### D43093-

base number    LED    Color    Finish  
 Dimming    Temperature    Options

- To build a product code in our configurator select the specify button on the base model # product page
- To build a manual product code on this datasheet choose from the options listed below in blue font and add the suffix to the base model #

#### GENERAL

Series: NoName  
 Partner: Icone  
 Division: Design  
 Installation: Surface  
 Product Type: Wall Surface  
 Mounting Location: Wall  
 Light Distribution: Indirect

#### PHYSICAL

Shape: Abstract  
 Length (mm): 300  
 Length (in): 11 <sup>13</sup>/<sub>16</sub>  
 Height (mm): 1315  
 Depth (mm): 130  
 Height (in): 51 <sup>3</sup>/<sub>4</sub>  
 Depth (in): 5 <sup>1</sup>/<sub>8</sub>  
 Fixture Finish: [BLK](#) / [WHB](#) / [WHW](#) / [BKB](#) / [BRA](#) / [SBS](#)  
 Fixture Material: Aluminum

#### ELECTRICAL

Lamp Type: LED  
 Input Wattage (W): 41.6  
 Dimming: [Phase Dimming](#) / [0-10V Dimming](#)  
 Driver Included: No  
 Driver Location: Remote  
 Driver Class: Class 2  
 Input Voltage (V): 120 - 277  
 Output Voltage (V): 24

#### LED

Color Temperature (°K): [2700](#) / [3000](#)  
 Max. Delivered Lumen (lm): 5700 / 5880  
 CRI: >80 CRI  
 Lamp Life (hrs): 50000

#### OPTICAL

#### RATINGS AND CERTIFICATIONS

Certified By: Certified for North American Standards  
 IP rating: IP20

PROJECT \_\_\_\_\_  
 TYPE \_\_\_\_\_  
 SPECIFIER \_\_\_\_\_  
 QUANTITY \_\_\_\_\_  
 DATE \_\_\_\_\_

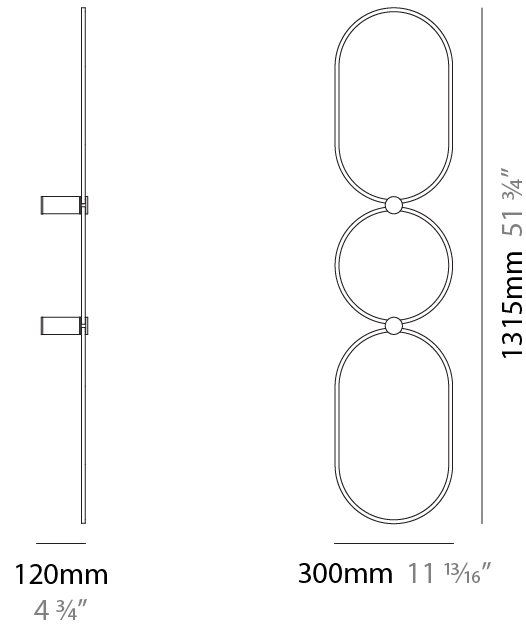
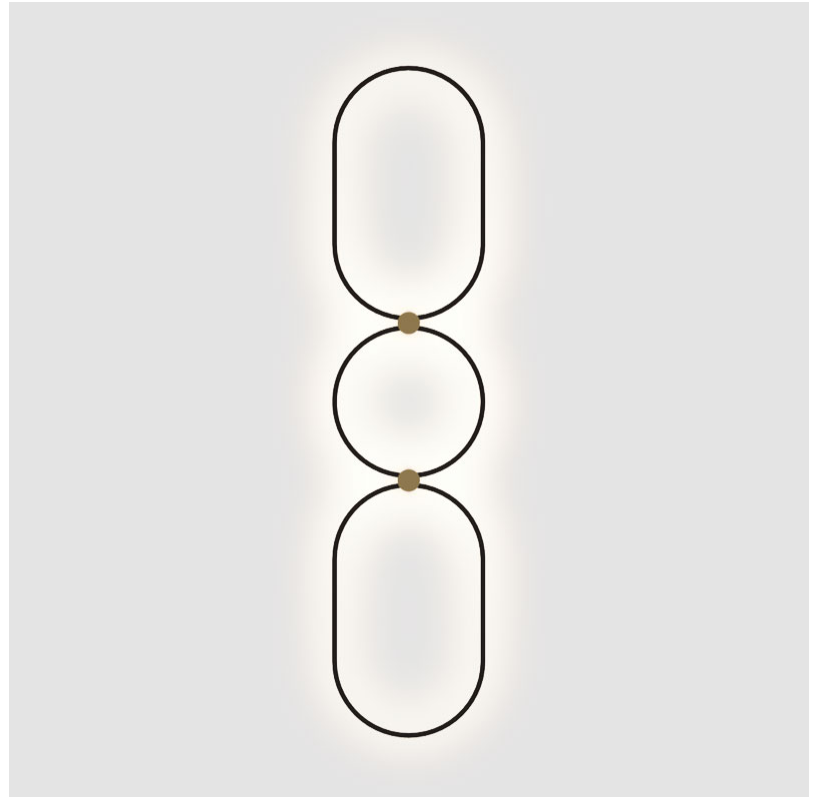

D43093-

PROJECT

TYPE

SPECIFIER

QUANTITY

DATE

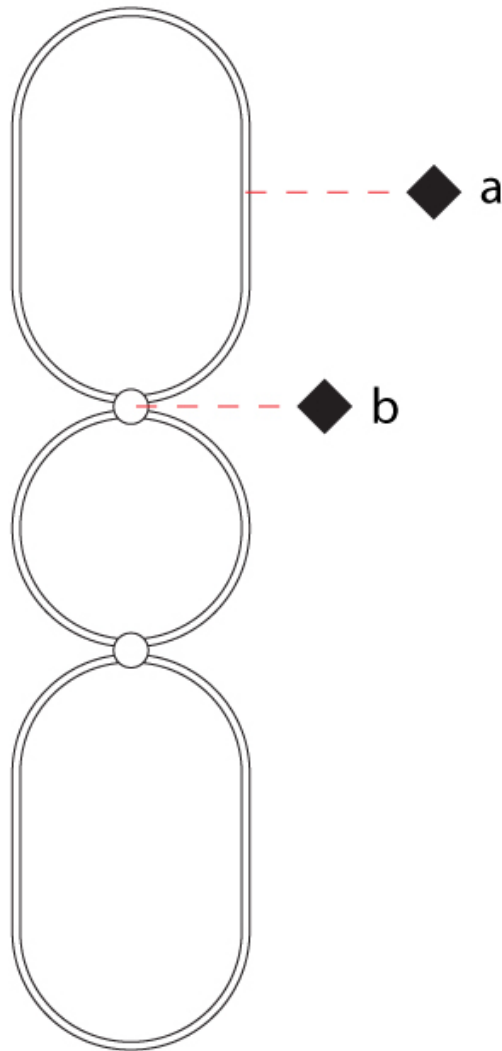

D

## NONAME SURFACE

### D43094-

base number    LED Dimming    Color Temperature    Finish Options

- To build a product code in our configurator select the specify button on the base model # product page
- To build a manual product code on this datasheet choose from the options listed below in blue font and add the suffix to the base model #

#### GENERAL

Series: NoName  
 Partner: Icone  
 Division: Design  
 Installation: Surface  
 Product Type: Wall Surface  
 Mounting Location: Wall  
 Light Distribution: Indirect

#### PHYSICAL

Shape: Abstract  
 Length (mm): 605  
 Length (in): 23 <sup>13</sup>/<sub>16</sub>  
 Height (mm): 910  
 Depth (mm): 130  
 Height (in): 35 <sup>13</sup>/<sub>16</sub>  
 Depth (in): 5 <sup>1</sup>/<sub>8</sub>  
[Fixture Finish: BLK / WHB / WHW / BKB / BRA / SBS](#)  
 Fixture Material: Aluminum

#### ELECTRICAL

Lamp Type: LED  
 Input Wattage (W): 51  
[Dimming: Phase Dimming / 0-10V Dimming](#)  
 Driver Included: No  
 Driver Location: Remote  
 Driver Class: Class 2  
 Input Voltage (V): 120 - 277  
 Output Voltage (V): 24

#### LED

[Color Temperature \(°K\): 2700 / 3000](#)  
 Max. Delivered Lumen (lm): 5700 / 5880  
 CRI: >80 CRI  
 Lamp Life (hrs): 50000

#### OPTICAL

#### RATINGS AND CERTIFICATIONS

Certified By: Certified for North American Standards  
 IP rating: IP20

PROJECT \_\_\_\_\_  
 TYPE \_\_\_\_\_  
 SPECIFIER \_\_\_\_\_  
 QUANTITY \_\_\_\_\_  
 DATE \_\_\_\_\_

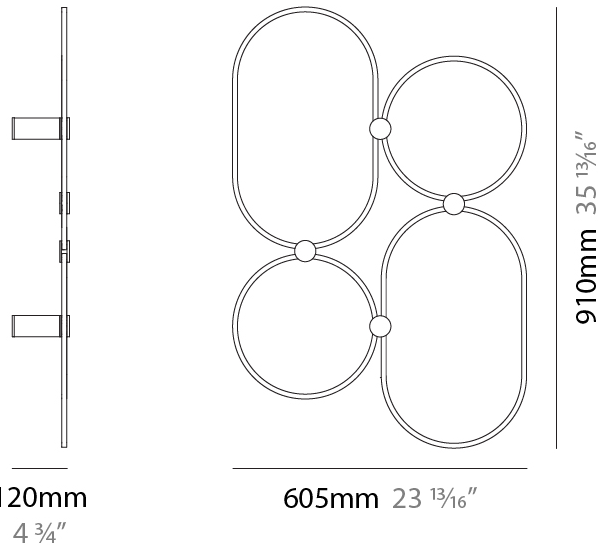
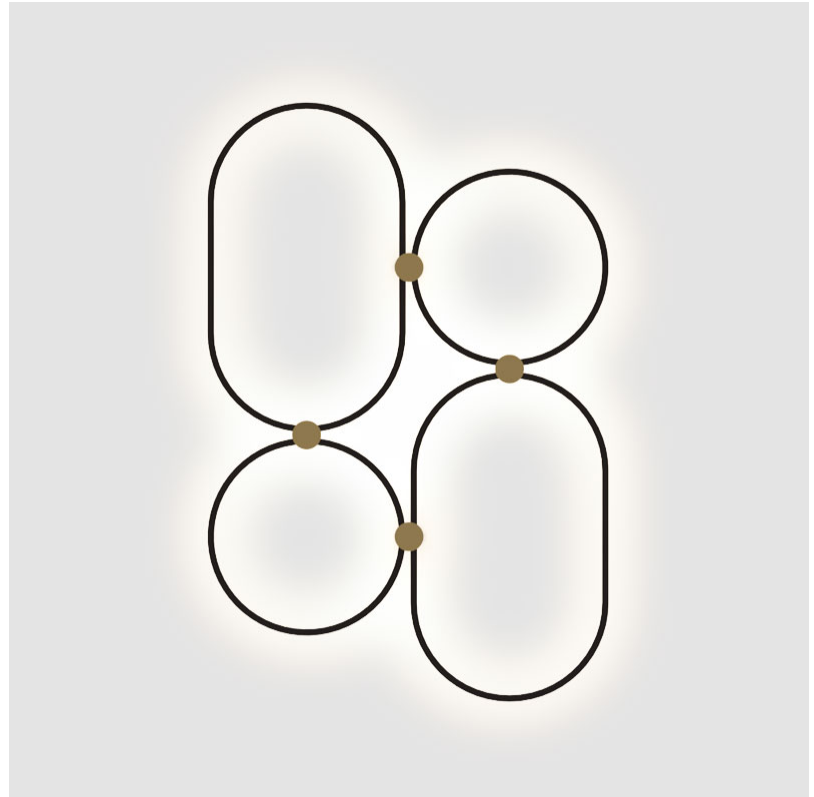

D43094-

PROJECT \_\_\_\_\_

TYPE \_\_\_\_\_

SPECIFIER \_\_\_\_\_

QUANTITY \_\_\_\_\_

DATE \_\_\_\_\_

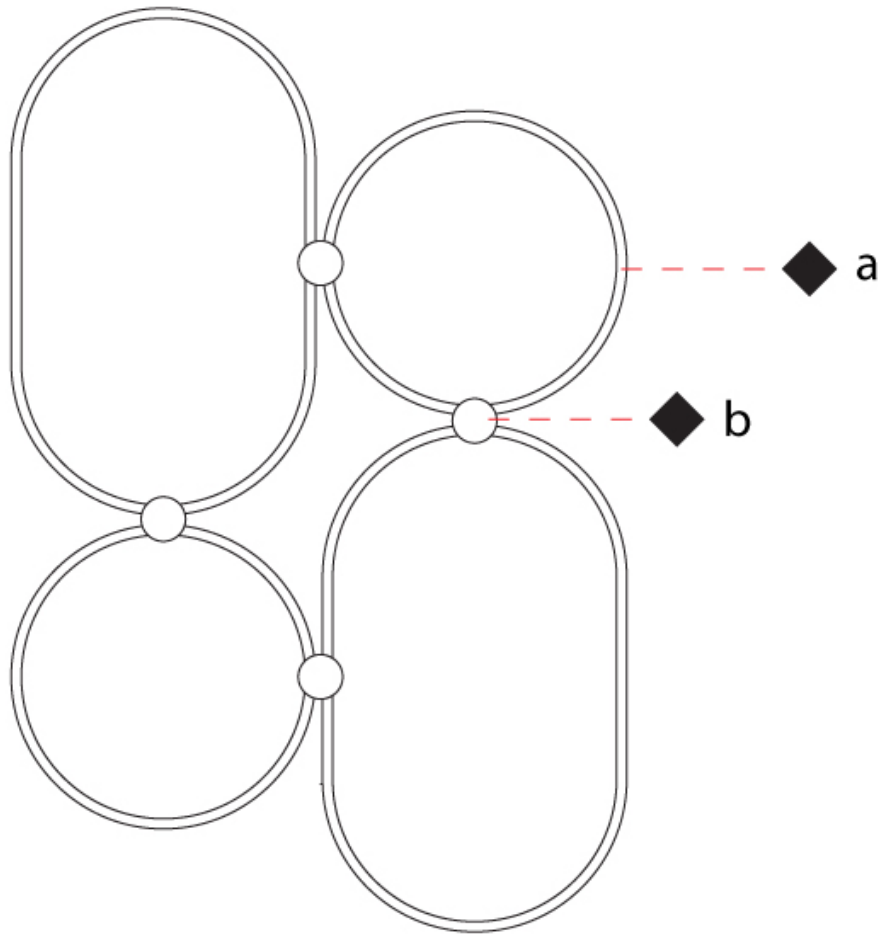

D

## NONAME SURFACE

### D43095-

base number    LED    Color    Finish  
 Dimming    Temperature    Options

- To build a product code in our configurator select the specify button on the base model # product page
- To build a manual product code on this datasheet choose from the options listed below in blue font and add the suffix to the base model #

#### GENERAL

Series: NoName  
 Partner: Icone  
 Division: Design  
 Installation: Surface  
 Product Type: Wall Surface  
 Mounting Location: Wall  
 Light Distribution: Indirect

#### PHYSICAL

Shape: Abstract  
 Length (mm): 920  
 Length (in): 36 3/4  
 Height (mm): 1315  
 Depth (mm): 130  
 Height (in): 51 3/4  
 Depth (in): 5 1/8  
 Fixture Finish: [BLK](#) / [WHB](#) / [WHW](#) / [BKB](#) / [BRA](#) / [SBS](#)  
 Fixture Material: Aluminum

#### ELECTRICAL

Lamp Type: LED  
 Input Wattage (W): 116  
 Dimming: [Phase Dimming](#) / [0-10V Dimming](#)  
 Driver Included: No  
 Driver Location: Remote  
 Driver Class: Class 2  
 Input Voltage (V): 120 - 277  
 Output Voltage (V): 24

#### LED

Color Temperature (°K): [2700](#) / [3000](#)  
 Max. Delivered Lumen (lm): 15900 / 16500  
 CRI: >80 CRI  
 Lamp Life (hrs): 50000

#### OPTICAL

#### RATINGS AND CERTIFICATIONS

Certified By: Certified for North American Standards  
 IP rating: IP20

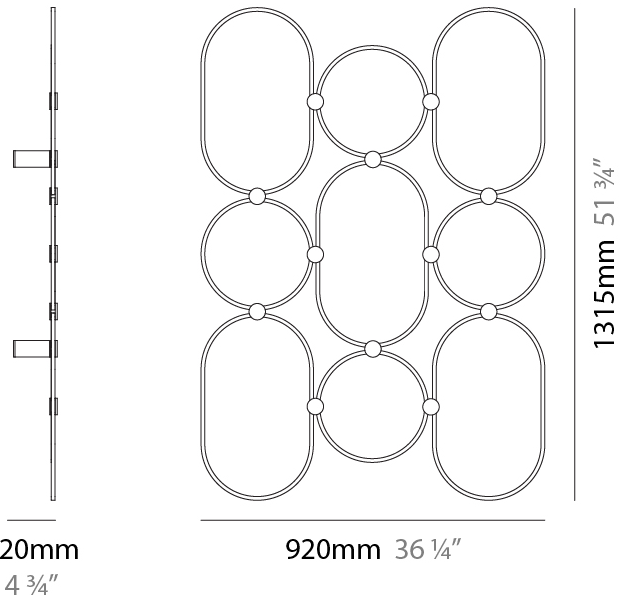
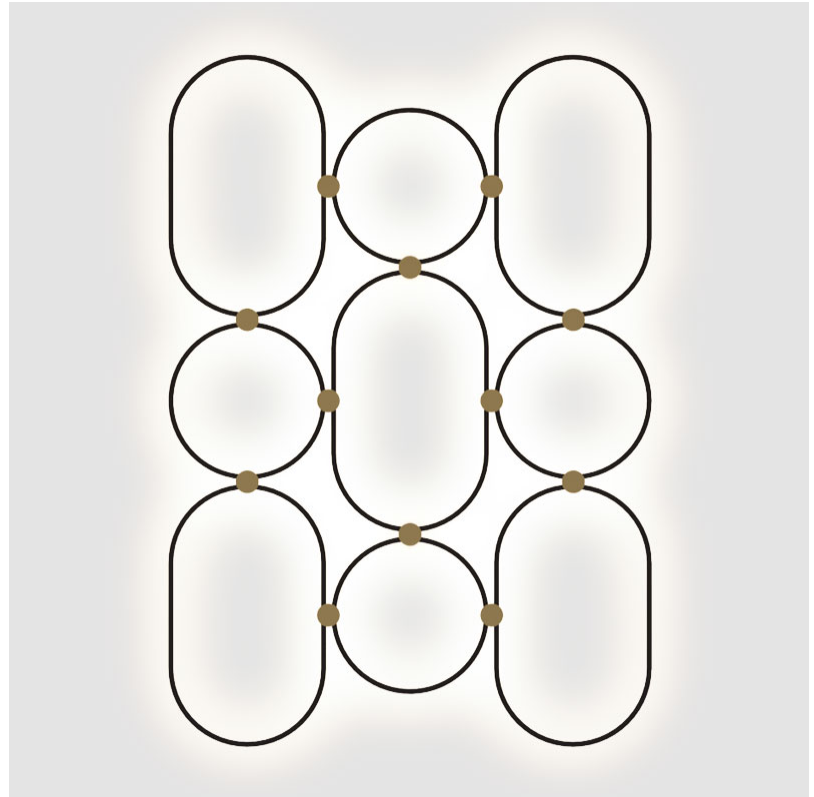

## NONAME SURFACE

D43095-

PROJECT	_____
TYPE	_____
SPECIFIER	_____
QUANTITY	_____
DATE	_____

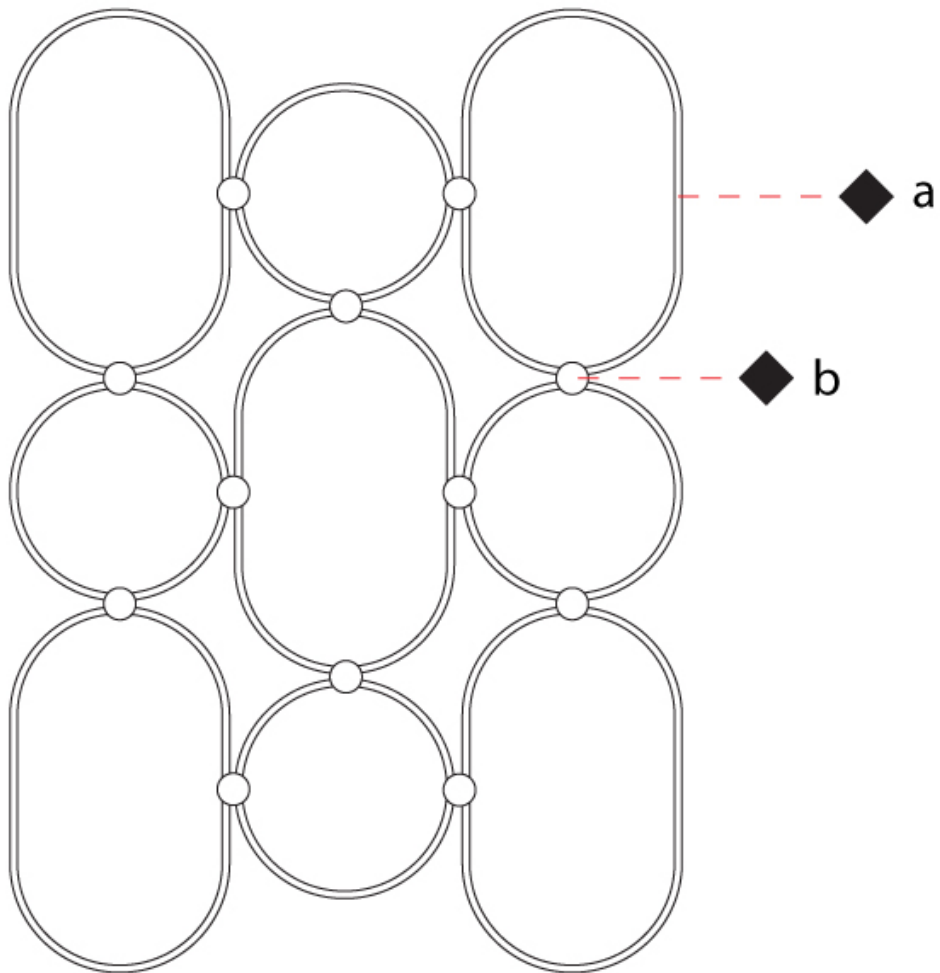

PROJECT \_\_\_\_\_

TYPE \_\_\_\_\_

SPECIFIER \_\_\_\_\_

QUANTITY \_\_\_\_\_

DATE \_\_\_\_\_

#### Fixture Finish

Black - BLK

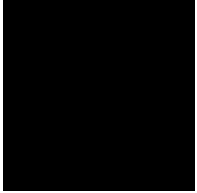

White/Brass - WHB



White/White - WHW

Black/Brass - BKB



Brass - BRA



Satin bronze / Brass - SBS

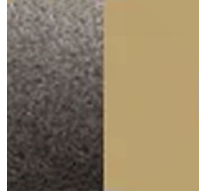





































































**Digital:** Not all screens are calibrated the same, and therefore, colors will appear differently between screens.











**Physical:** When texture is involved, there will be variations in color, character and tone within a product series and between product families.













### LEGEND

	floor-mounted		pivotal		special LED (upon request) RGB, RGBW, tunable, gold+, meat+, art+, fashion+
	wall and ceiling: recessed and surface mounted		rotating		warm dim / natural dimming LED
	ceiling-mounted and wall-mounted		illuminate tilted		rechargeable battery powered
	wall-mounted		color of suspension cable		fixture with natural vivid LED (upon request)
	omni-directional light distribution		length of suspension cable		color rendering index
	direct light distribution		reflector degree selection		color temperature
	direct/indirect light distribution		super spot		lumen (luminous flux)
	indirect light distribution		lens		efficacy (lumens per watt)
	asymmetric light distribution		lens pack		Unified Glare Rating (UGR) range from 5-40
	aura light distribution		shine ring		marine grade (AISI 316 stainless steel)
	round wall or ceiling cut-out		integrated shine ring with diffuser		walk on
	square wall or ceiling cut-out		free individual colors 01-29		drive on
	the supplied jig specifies the cutout dimensions		individual colors: 00 (free of charge), 01-25 (extra charge)		Dark Sky Compliance
	minimum distance (meters) lamp - object		luminaire part to be colored (F1)		Americans with Disabilities Act (less than 4" off the wall located between 27"-84" from floor)
	recessed depth		luminaire part to be colored (F2)		lamp protected against explosion
	ceiling thickness in mm		luminaire part to be colored (F3)		blown glass using traditional methods by master glass blower
	ceiling thickness selection		luminaire part to be colored (F4)		acoustic material
	dimnable DP (phase), DV (0-10V), DD (dali), DS (step-dim)		luminaire part to be colored (F5)		protection class I, protection insulation
	included or excluded LED driver/transformer/control gear		color of 3-circuit adaptor		protection class II, protection insulation
	separately switchable		indirect diffuser		ETL Certified to UL and CSA Standards
	sensor		direct diffuser		UL Certified to UL and CSA Standards
	remote control		ball-proof (upon request)		CSA Certified to UL and CSA Standards
	available upon request		accessory		Certified for North American Standards

### IP RATING

	protected against ingress of solid bodies greater than 12.5mm (finger)
	protected against ingress of solid bodies greater than 2.5mm protected against sprays of water up to 60 degrees from the vertical (rain)
	protected against ingress of solid bodies greater than 1mm (wire) no protection against the ingress of moisture
	protected against ingress of solid bodies greater than 1mm (wire) protected against sprays of water up to 60 degrees from the vertical (rain)
	protected against ingress of solid bodies greater than 1mm (wire) protected against water splashed from all directions
	protected against limited ingress of dust (wet rooms/covered outdoor areas) protected against water splashed from all directions
	protected against ingress of dust protected against jets of water
	protected against ingress of dust protected against powerful jets of water or heavy seas
	protected against ingress of dust protected against immersion of water between 15cm - 1m for 30 minutes
	protected against ingress of dust protected against immersion of water under pressure for long periods

### IK RATING

	protected against 0.14 joules impact (equivalent to 0.25kg mass dropped from 56mm above the surface)
	protected against 0.2 joules impact (equivalent to 0.25kg mass dropped from 80mm above the surface)
	protected against 0.35 joules impact (equivalent to 0.25kg mass dropped from 140mm above the surface)
	protected against 0.5 joules impact (equivalent to 0.25kg mass dropped from 200mm above the surface)
	protected against 0.7 joules impact (equivalent to 0.25kg mass dropped from 280mm above the surface)
	protected against 1 joules impact (equivalent to 0.25kg mass dropped from 400mm above the surface)
	protected against 2 joules impact (equivalent to 0.5kg mass dropped from 400mm above the surface)
	protected against 5 joules impact (equivalent to 1.7kg mass dropped from 300mm above the surface)
	protected against 10 joules impact (equivalent to 5.0kg mass dropped from 200mm above the surface)
	protected against 20 joules impact (equivalent to 5.0kg mass dropped from 400mm above the surface)